

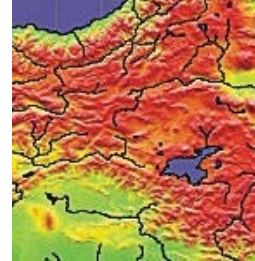

## ***Domal uplift and volcanism in a collision zone without a mantle plume: Evidence from Eastern Anatolia***



**Mehmet Keskin**

Istanbul University, Faculty of Engineering, Dept. of Geological Engineering, 34850  
Avcilar,  
Istanbul, Turkey.

April 2005

[keskin@istanbul.edu.tr](mailto:keskin@istanbul.edu.tr)

### **Abstract**

*The Eastern Anatolia region is one of the best examples of a continental collision zone in the world. It also comprises one of the high plateaus of the Alpine-Himalaya mountain belt with an average elevation of ~2 km above sea level (Fig. 1). It displays shallow and diffuse seismicity (Fig. 2), indicating that the lithosphere is still being actively deformed as a result of diffuse north-south shortening. This implies that the collision is still in progress. Previous studies have shown that the Arabian plate made its initial contact with the Eurasian plate during the Late Eocene. The region underwent compressional tectonic evolution subsequently, but most of it lay beneath sea level during a period between the Late Eocene (~50 Ma) and Serravalian (~13 Ma). At about 13 Ma, the region was subjected to abrupt block uplift and consequently elevated above sea level. Uplift was followed by subaerial volcanic activity. Volcanism intensified and had become widespread all over the region by about 7-8 Ma, while the region gradually acquired a regional domal shape comparable to that of the Ethiopian High Plateau. However, the dome structure in Eastern Anatolia has a north-south shortened asymmetrical shape, due to the compressional tectonic regime created by collision, in contrast to that of the Ethiopian High Plateau. At present, it is difficult to recognise the dome in topographic maps since the topography of the region has been strongly modified by volcanoes and river drainage systems.*

*Volcanism migrated to the south/southeast over time. Great volumes of volcanic material (i.e. lavas and pyroclastic units) reaching over 1 km in thickness in places were erupted onto the surface between 8 and 1.5 Ma, forming volcano-sedimentary successions, and covering almost two-thirds of the region. Thus, the Eastern Anatolia region can be regarded as the site of a "melting anomaly" or "hotspot" resembling closely the setting proposed for mantle plumes. However, geologic and geochemical data provide evidence against a plume origin. In addition, the results of new geophysical studies, coupled with geologic and geochemical findings, support the view that both domal uplift and extensive magma generation can be linked to the mechanical removal of a portion or the whole thickness of the mantle lithosphere, accompanied by passive upwelling of normal-temperature asthenospheric mantle to a depth as shallow as 50 km. This process is argued to have occurred either by delamination, slab-steepening and breakoff, or a combination of both. Therefore, magma generation beneath Eastern Anatolia may have been controlled by adiabatic decompression of the asthenosphere. The presence of a subduction component and thus water in the asthenospheric mantle wedge would have played an important role in this melting process. In addition, material derived from previously subducted slabs might have contributed to the fertility of the mantle source region.*

The Eastern Anatolian example is important in showing that not only plumes but also shallow plate tectonic processes have the potential to generate regional domal structures in the Earth's lithosphere as well as large volumes of magma, as proposed by a number of recent studies.

**Introduction**

Orogenic belts formed by collisions between continents contain invaluable records of the geological history of the Earth and therefore have always attracted the attention of Earth scientists. The Eastern Anatolia Region, exhibiting plateau morphology with an elevation 1500 – 2000 m above sea level, is one of two regions where active continent-continent collision is currently taking place, the other being the Tibetan Plateau (Fig. 1). Therefore, the Eastern Anatolia region is a spectacular natural laboratory where the early stages of a continent-continent collision and their effects can be thoroughly studied.

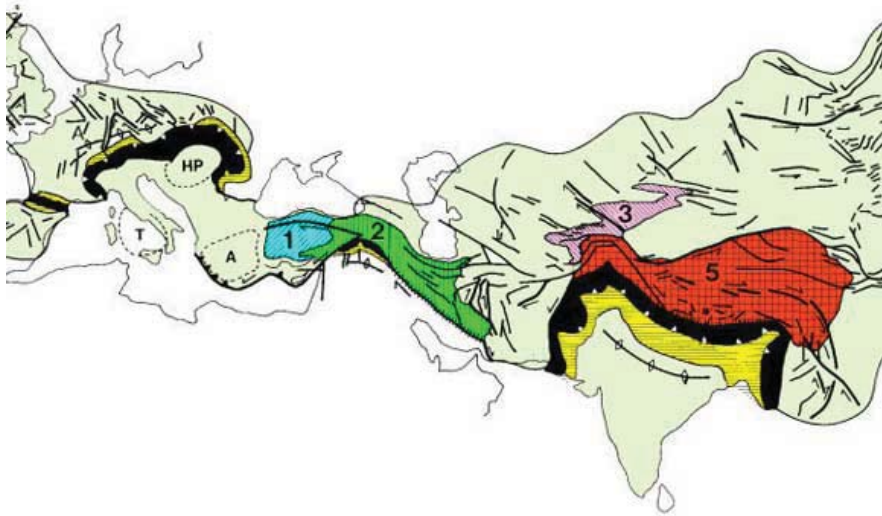

Figure 1. Plateaus in the Alpine/Himalayan mountain belt. Black: thrust belts; yellow: foreland and hinterland basins. Numbers refer to the average height of the plateaus. 1: Western Anatolian plateau (1 km); 2: Eastern Anatolian Plateau (2 km); 3: Tien Shan (3 km); 5: Tibet (5 km) [Fig. 1 from Dewey et al., 1986].

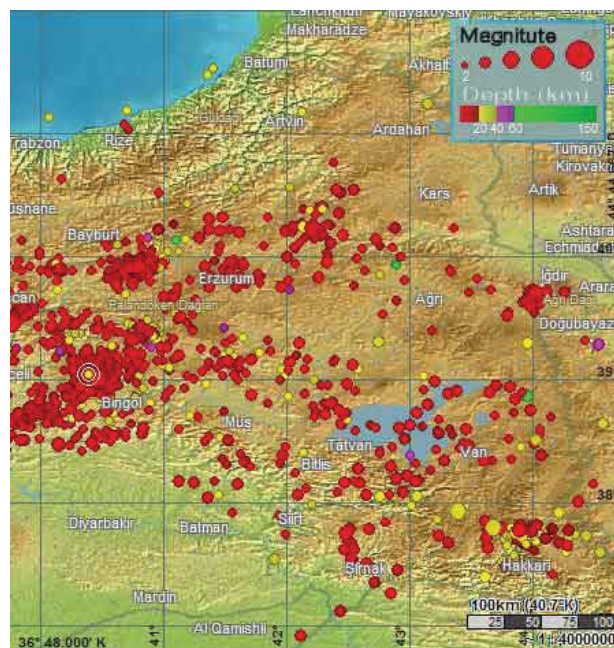

Figure 2 (Previous page). Distribution of earthquake epicentres, magnitudes and depths across the Eastern Anatolia region. The map includes recorded earthquakes from 1<sup>st</sup> December 1999 to 23<sup>rd</sup> March 2005. The figure is a screenshot from the Earthquake Monitor program of Gezdirici [2001]. Red circles are hypocentres which are shallower than 20 km (see figure legend).

Previous studies to date [e.g., Sengor & Kidd, 1979; Dewey *et al.*, 1986] have shown that collision occurred between the Eurasian and Arabian continents, resulting in the formation of an extensive (~ 150,000 km<sup>2</sup>) high plateau with an average elevation of 2 km above sea level (Fig. 3). These studies also revealed that the region has reached this elevation as a block since the Serravalian (~ 13-11 Ma: Gelati, 1975), when the terminal collision of Arabia with Eurasia started [Sengor & Kidd, 1979].

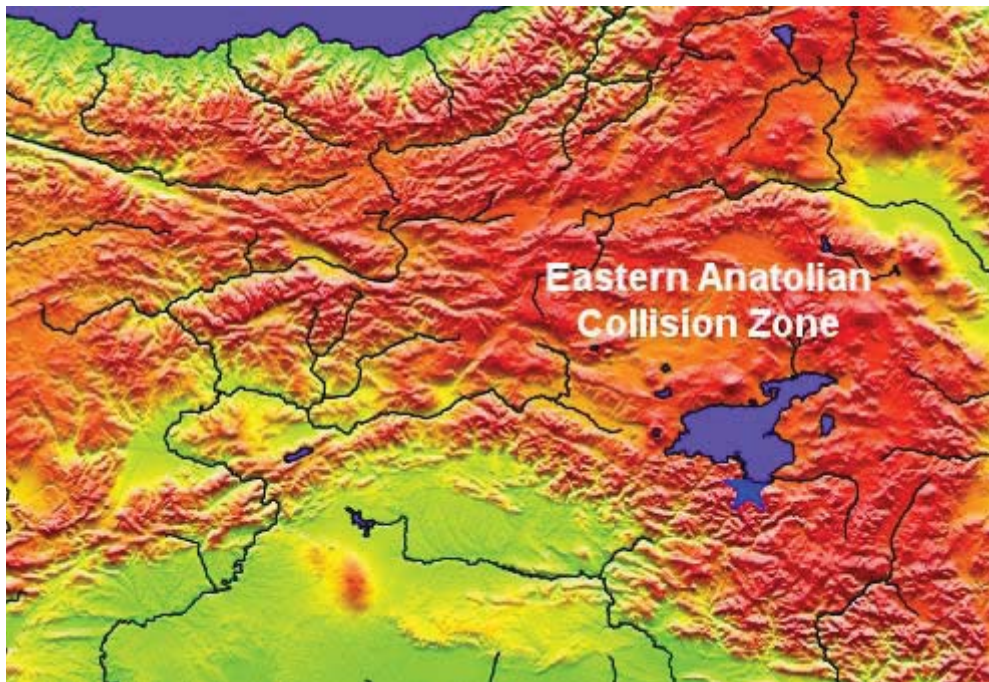
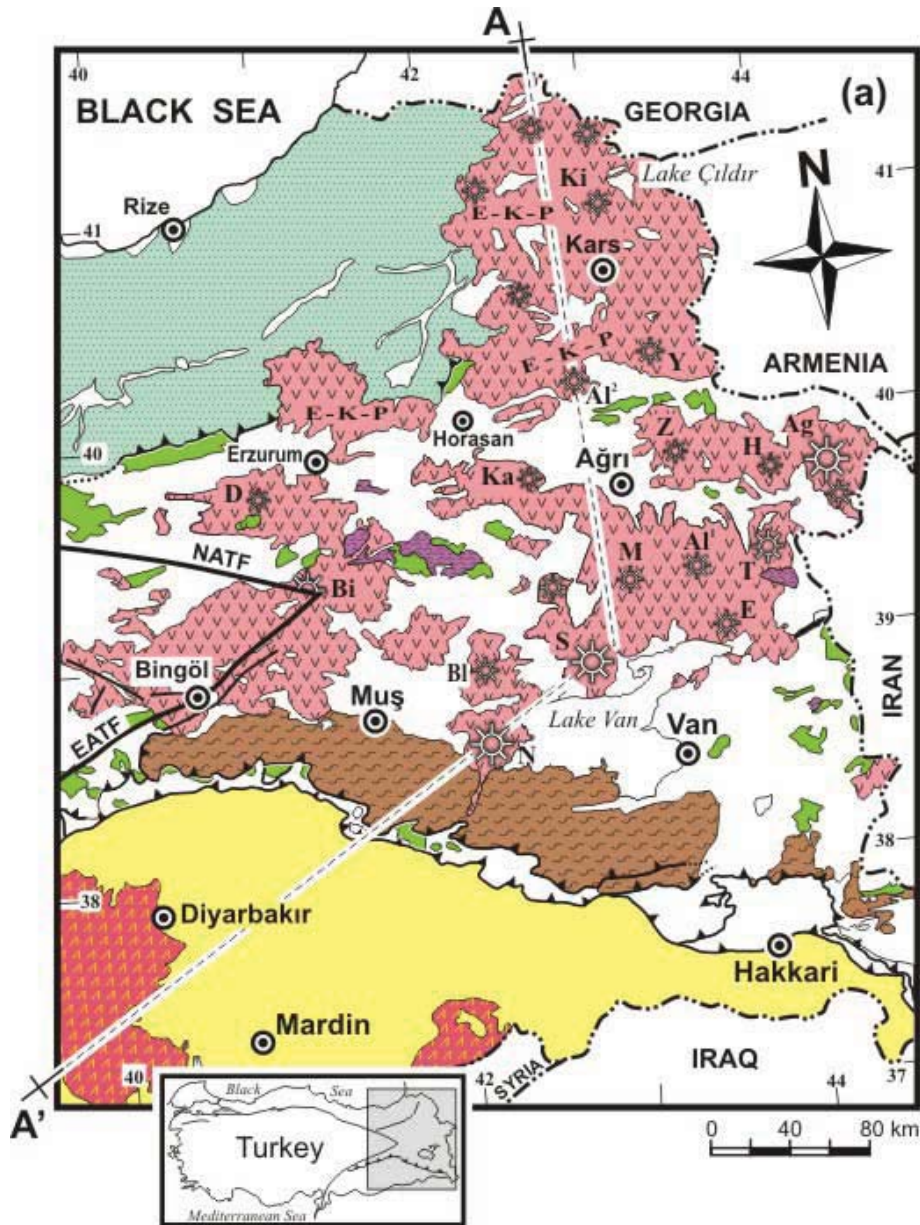

Figure 3. Topographic map showing the Eastern Anatolian plateau with an average elevation of 2 km above sea level. See Figs. 4, 5 and 6 for the main tectonic lines and stratigraphic units.

Volcanic activity initiated immediately after the rapid block uplift of Eastern Anatolia and became widespread all over the region, producing subaerial lava flows and pyroclastic products which are very variable in their composition and eruptive style [Pearce *et al.*, 1990; Keskin *et al.*, 1998; Yilmaz *et al.*, 1998]. The volcanic activity initiated in the north around the Erzurum-Kars Plateau and migrated to the south-southeast [Keskin, 2003] (Fig. 7). A vast volume of volcanic material was produced by this activity, covering almost two thirds of the region and reaching over 1 km in thickness in some localities (Figs. 4, 5 and 6).



**EXPLANATIONS**

- |   |  |
|---|--|
| <ul style="list-style-type: none"> <li> Collision-related volcanic units underlain by the Pontides and EAAC.</li> <li> Collision-related volcanic units on the Arabian foreland (Mt. Karacalidag).</li> <li> The Pontide unit.</li> <li> Ophiolites related to the Eastern Anatolia Accretionary Complex (EAAC).</li> <li> Large metamorphic blocks in the EAAC.</li> <li> The Bitlis-Pötürge Massif (BPM).</li> <li> Units of the Arabian foreland.</li> </ul> | <ul style="list-style-type: none"> <li> Volcanic centers.</li> <li> Cities.</li> <li> Major strike-slip faults</li> <li> Major thrust faults.</li> <li> Locations of radiometric age determinations and ages in My.</li> </ul> |
|---|--|

Figure 4. Simplified geological map of the Eastern Anatolia region showing tectonic units, collision-related volcanic products and volcanic centres (compiled by Keskin, 2003). A-A': direction of the cross section given in Fig. 8. E-K-P: the Erzurum-Kars Plateau; NATF and EATF: North and East Anatolian Transform Faults. **Volcanic centers:** Ag: Mt. Agri (Ararat), Al': Mt. Aladag (SE of Agri), AP: Mt. Aladag (NW of Horasan), Bi: Mt. Bingöl, Bl: Mt. Bilicandagi, D: Mt. Dumanlidag, E: Mt. Etrusk, H: Mt. Hamadag, K: Mt. Karatepe, Ki: Mt. Kisirdag, M: Mt. Meydandag, N: Mt. Nemrut, S: Mt. Suphan, T: Mt. Tendürek, Y: Mt. Yaglicadag, Z: Mt. Ziyaretdag.

Although fissure eruptions dominated the volcanic activity, there are over 20 volcanic centres (e.g., Mt. Nemrut, Mt. Ararat, Mt. Tendurek) in the region, corresponding basically to central eruption sites (Figs. 4 and 9). The erupted volumes may represent only a small fraction of the melt generated beneath the region, because a greater proportion presumably was emplaced deeper in the crust as plutonic intrusions. Thus, there must have been enormous magma generation beneath the whole region related to the collision of Arabia with Eurasia. As a result, Eastern Anatolia can be regarded as one of the Earth's major "hotspots" or a "melting anomalies".

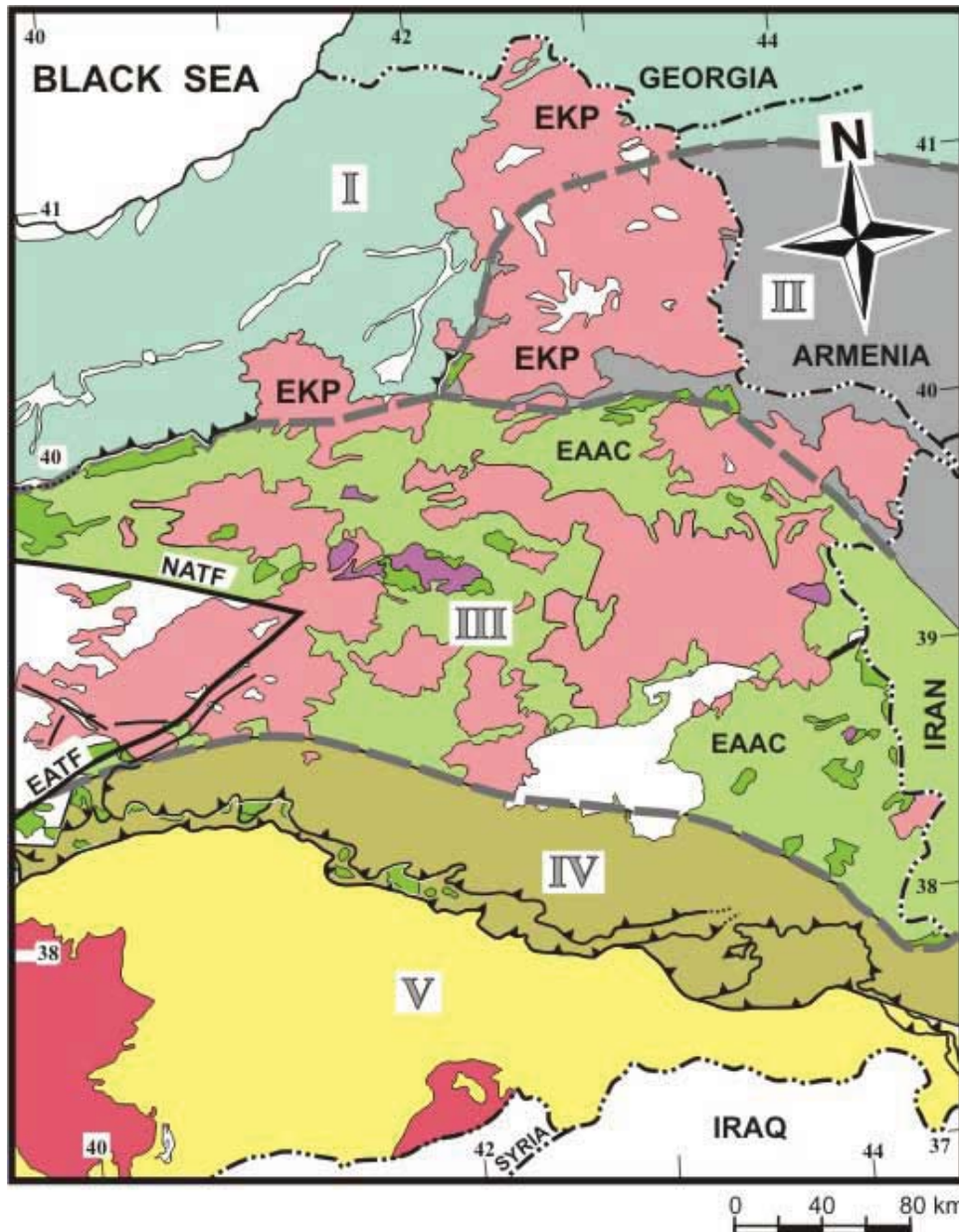

Figure 5. Major tectonic blocks of the Eastern Anatolia region. The borders are modified from Sengor et al. [2003]. I: Rhodope-Pontide fragment, II: Northwest Iranian fragment, III: Eastern Anatolian Accretionary Complex (EAAC), IV: Bitlis-Poturge Massif, V: Arabian foreland. Dark green areas: outcrops of ophiolitic melange, Pink and red areas: collision-related volcanic units, white areas: undifferentiated units or young cover formations. EKP: the Erzurum-Kars Plateau in the north.

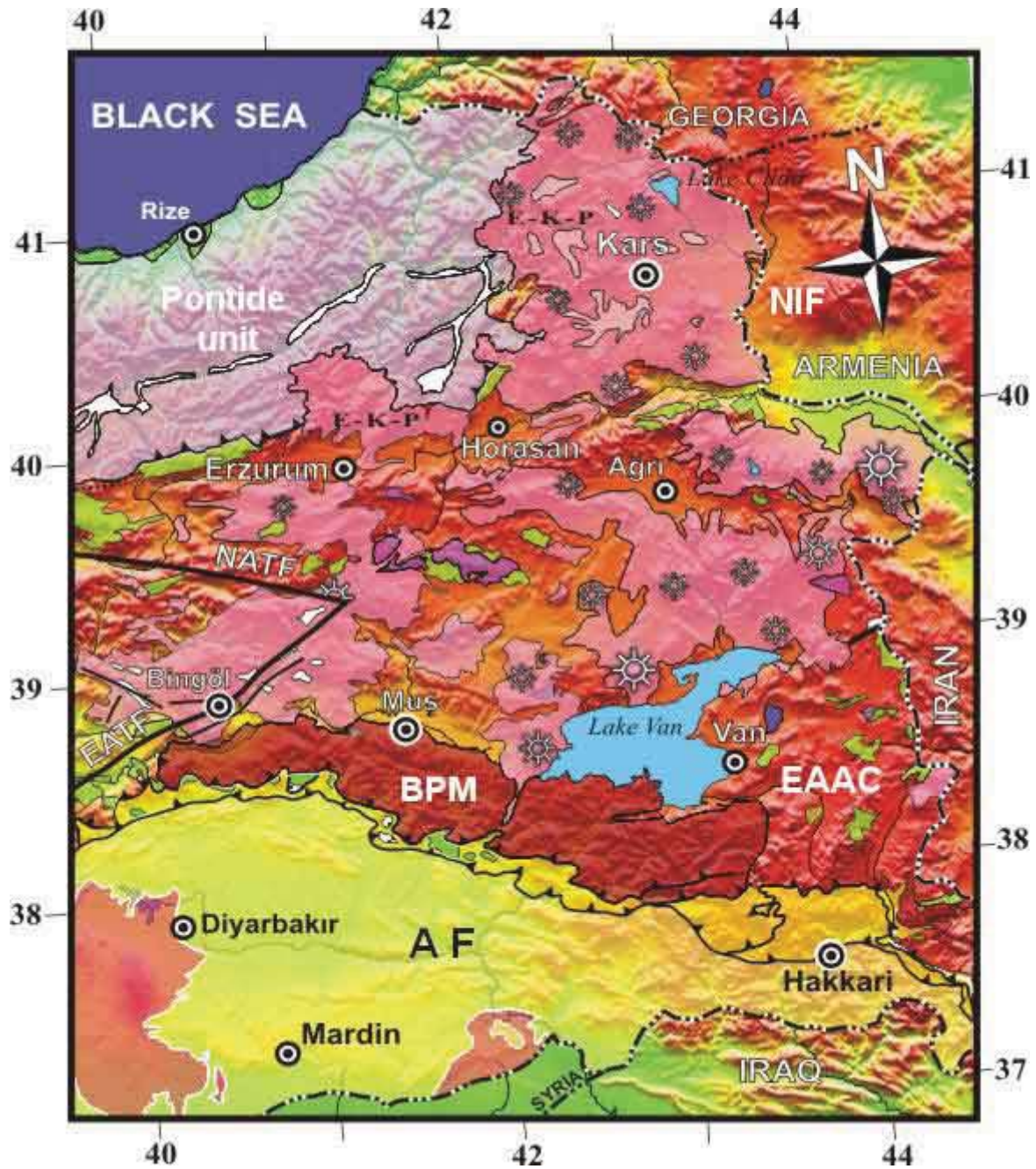

Figure 6. Topographic map of the Eastern Anatolia Collision Zone (EACZ) over which the main tectonic units as well as collision-related volcanics are superimposed. NIF: Northwest Iranian Fragment, BPM: Bitlis-Poturge massif, EAAC: Eastern Anatolian Accretionary Complex, AF: Arabian Foreland. For more explanation, see [Figs. 4](#) and [5](#).

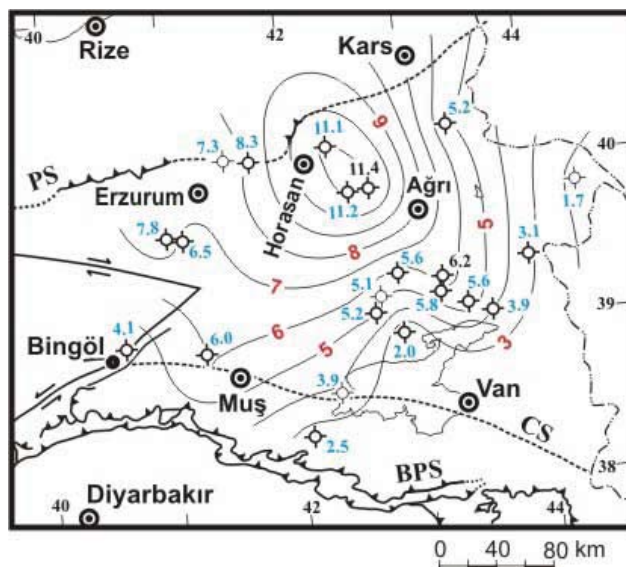

Figure 7. Distribution of the oldest radiometric ages of the volcanic units. Ages are from Pearce et al. [1990], Ercan et al. [1990] and Keskin et al. [1998]. Initiation ages of the volcanism are contoured in 1-Myr intervals. PS: Pontide suture, BPS: Bitlis-Poturge suture, CS: inferred cryptic suture between the EAAC and BPS. Figure from Keskin [2003].

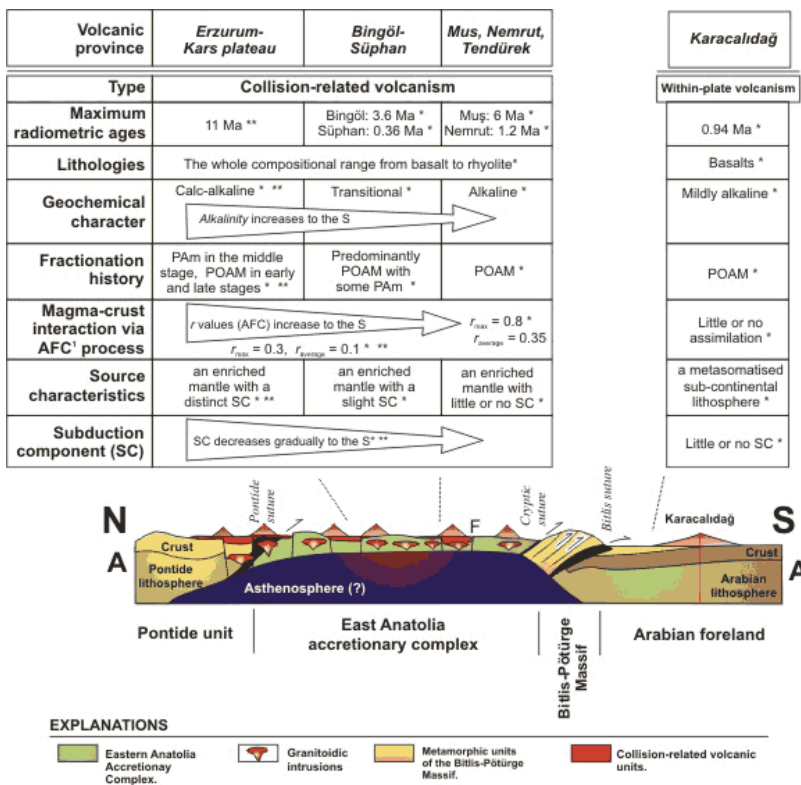

Figure 8. Cross section summarizing the crustal structure and petrologic/geochemical properties of the collision-related volcanic units across the Eastern Anatolia Region [Keskin, 2003]. The crustal and lithospheric thicknesses are from Sengor et al. [2003] and Zor et al. [2003]. The direction of the cross section (A-A') is shown in Fig. 4. Source of geochemical data: \*Ercan et al. [1990], \*\*Pearce et al. [1990], \*\*\*Keskin et al. [1998]. SC: subduction component, AFC: Assimilation combined with fractional crystallization process,  $r$ : ratio of the rates of mass assimilation and mass crystallization. F: strike-slip faults.

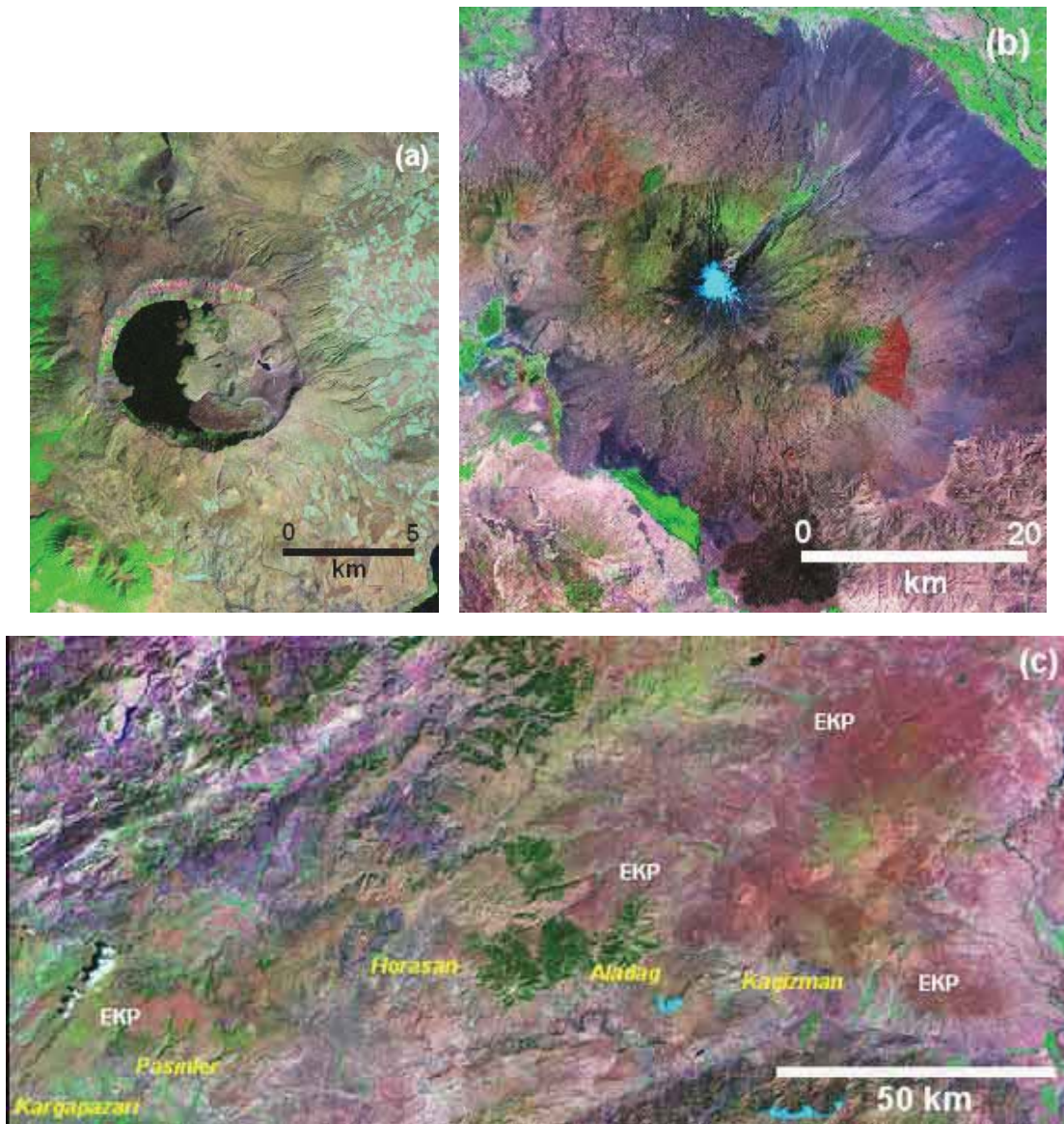

Figure 9. MrSID satellite view of (a) Mt. Nemrut volcano in the south, (b) Mt. Ararat: a double-peaked strato-volcano in the northeast, and (c) the Erzurum-Kars Plateau (EKP) in the northernmost part of the Eastern Anatolia region. On the Erzurum-Kars Plateau (i.e. c) Reddish coloured areas marked EKP correspond to volcanic units, while purple to pinkish areas are either basement units (e.g., areas in the northwest) or young sedimentary cover formations. Vegetation is represented by green areas. For the exact regional locations of Mt. Nemrut and Mt. Ararat, see [Fig. 4](#).

The East Anatolian topographic uplift resembles the Tibetan Plateau and has been viewed as a younger version of it in many studies [e.g., Sengor & Kidd, 1979; Dewey et al., 1986; Barazangi, 1989]. In these studies, the Eastern Anatolian lithosphere is thought to have doubled in thickness (to ~ 250-300 km) as a result of collision ([Fig. 10](#)). However, recent geophysical studies have revealed that the mantle lithosphere is almost completely absent beneath a greater portion of the region [Gök et al., 2000, 2003; Al-Lazki et al., 2003] ([Fig. 8](#)). Moreover, studies of receiver functions indicate that the crust beneath the region ranges in thickness between 38 and 50 km, averaging ~ 40–45 km [Zor et al., 2003]. This indicates that an almost normal-thickness crust is underlain by an extremely thin mantle lithosphere or perhaps almost directly by the asthenosphere. Such a lithospheric thickness can be considered to be normal in extensional areas, such as Iceland, but unusual in a continental collision setting with a compressional tectonic regime.



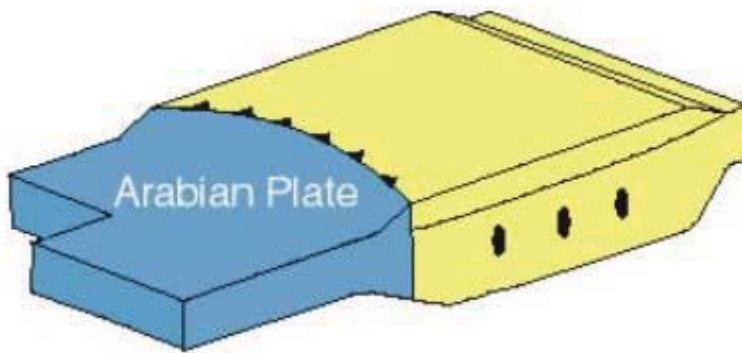

Figure 10:  
Continental collision and subsequent thickening of the Anatolian crust/lithosphere [Dewey et al., 1986].

On the basis of these results and the geology of the region, Sengor et al. [2003] proposed that the East Anatolian high plateau is a mantle-supported, *north-south shortened domal structure*, whose E-W topographic profile along the 40°N parallel is very similar to that of the Ethiopian High Plateau (Fig. 11).

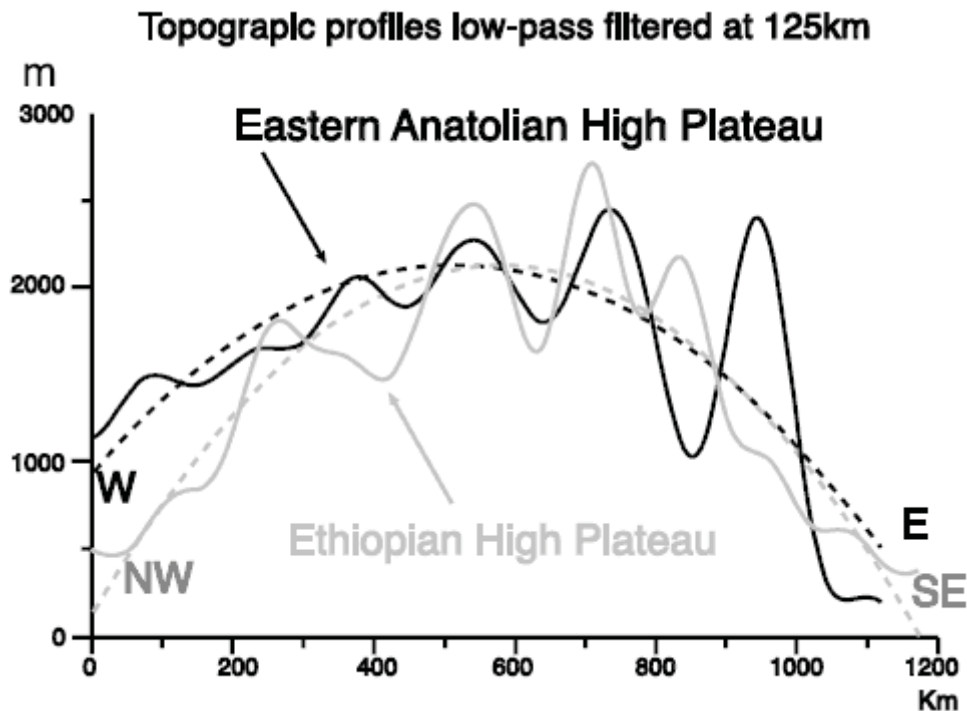

Figure 11. Figure 4 from Sengor et al. [2003]. Comparison of the topography of Ethiopia with an E-W profile along the 40° parallel in Eastern Anatolia. The smooth lines represent least squares simplifications of the topography.

When these findings and interpretations are taken into account, it can be argued that Eastern Anatolia represents a tectonically-deformed, N-S shortened lithospheric dome structure, supported by an asthenospheric upwelling (see cross section in Fig. 8). Thus, Eastern Anatolia closely resembles a mantle plume setting. However, geologic and geochemical data indicate that a mantle plume setting cannot be a viable model for the region as I discuss in the following sections.

The rest of this web-page deals with a number of problems including:

- how great volumes of collision-related magma were generated in the region,
- how and why the region gained its elevation and the aforementioned domal shape in the

- absence of a mantle plume, and
- what tectonic processes are responsible for both magma generation and the regional uplift.

It is organized as follows:

- Section I focuses on the geology of the region,
- Section II deals with the geochemical characteristics of the collision-related volcanic units,
- Section III describes the results of the **Eastern Turkey Seismic Experiment** project,
- Section IV discusses ten competing geodynamic models proposed for the region with emphasis on the inherent discrepancies in each model.
- Section V is a discussion.

## 1. Geology

There are two main plateaus in the Alpine-Himalayan collision system ([Fig. 1](#)):

1. The Anatolian – Iranian plateau (1 and 2 in [Fig. 1](#)),
2. The Tibetan plateau (5 in [Fig. 1](#)) [[Sengor & Kidd, 1979](#); [Dewey et al., 1986](#)].

The Anatolian – Iranian Plateau extends from Eastern Anatolia to Eastern Iran, and typically has an elevation of about 1.5 – 2 km in Eastern Anatolia. The basement of the Anatolian – Iranian Plateau is made up of micro-continents, accreted to each other during the Late Cretaceous to Early Tertiary [[Sengor, 1990](#)]. These micro-continents are separated from each other by ophiolite belts and accretionary complexes.

Five different tectonic blocks are recognised in North-Eastern Anatolia ([Fig. 5](#)):

- I. The Eastern Rhodope-Pontide fragment in the northwest of the region (I in [Fig. 5](#)). It underlies the south-western and north-eastern parts of the Erzurum Kars Plateau (i.e. EKP in [Fig. 5](#)).
- II. The Northwest Iranian fragment (II in [Fig. 5](#)). The eastern part of the Erzurum-Kars Plateau (i.e. Horasan, Aladag, Kagizman, Kars areas and Mt. Ararat) overlies this tectonic block [[Keskin et al., 1998](#)],
- III. The Eastern Anatolian Accretionary Complex in the middle of the region located between the Aras River and the Bitlis-Poturge Massif (III in [Fig. 5](#)),
- IV. The Bitlis-Pötürge unit which is exposed along the Taurus belt (IV in [Fig. 5](#)), and
- V. Autochthonous units of the Arabian continent or foreland (V in [Fig. 5](#)).

Except for the EAAC, all the tectonic blocks correspond to the aforementioned micro-continents.

The Eastern Rhodope-Pontide unit is located in the northernmost part of the region. Its basement is represented by a metamorphic massive named the Pular Complex [[Topuz et al., 2004](#)]. The Pular complex is composed of a heterogeneous set of granulite facies rocks, ranging from quartz-rich mesocratic gneisses to silica- and alkali-deficient, Fe-, Mg- and Al-rich melanocratic rocks [[Topuz et al., 2004](#)]. A thick volcano-sedimentary arc sequence overlies this metamorphic basement. This sequence is regarded as an ensialic, south-facing magmatic arc, formed by north-dipping subduction under the Eurasian continental margin [[Yilmaz et al., 1997](#)] in a period between the Albian and Oligocene [[Sengor et al., 2003](#)].

The Northwest Iranian fragment is masked by collision-related volcanic units in Eastern Anatolia. It is exposed in Armenia around the Tsakhkuniats basement outcrop and Hankavan-Takarly and Agveran massifs [[Karapetian et al., 2001](#)]. The unit is composed of a heterogeneous rock sequence, consisting of trondhjemitic, phyllitic, albite-plagiogranitic, plagiogranite- and granite-

migmatitic lithologies [Karapetian *et al.*, 2001].

The Eastern Anatolian Accretionary Complex (EAAC) forms a 150-180 km wide, NW-SE extending belt in the middle of the region. It represents the remnant of a huge subduction-accretion complex formed on a north-dipping subduction zone located between the Rhodop-Pontide in the north and the Bitlis-Poturge microcontinent in the south in a period between the Late Cretaceous and Oligocene [Sengor *et al.*, 2003]. It consists of two contrasting rock units:

1. An ophiolitic melange of Late Cretaceous age, and
2. Paleocene to Late Oligocene flysch sequences incorporated into the ophiolitic melange as north-dipping tectonic slices. These flysch slices become younger from north to south and shallower from the Cretaceous to the Oligocene [Sengor *et al.*, 2003]. This observation is consistent with the polarity of the subduction zone that is thought to have created the Eastern Anatolian accretionary prism by underthrusting.

The Bitlis-Poturge Massif is exposed in a NW-SE extending belt along the Eastern Taurus mountain range. It is regarded as the easternmost extremity of the Menderes-Taurus block. It consists of medium-to-highly metamorphosed units.

Shallow marine deposits of Oligocene to Middle Miocene age unconformably overlie these tectonic blocks in some places (not shown in [Figs. 4](#) and [5](#)). Collision-related volcanic units, on the other hand, unconformably overlie both these five tectonic blocks and the aforementioned marine deposits, masking the basement units over great distances ([Figs. 4](#), [5](#) and [6](#)). These volcanic units become younger to the south/southeast [Keskin, 2003] ([Fig. 7](#)).

## **2. Lithospheric structure of the region based on the results of the Eastern Turkey Seismic Experiment project**

Results from the **Eastern Turkey Seismic Experiment** project [ETSE project: Al-Lazki *et al.*, 2003; Gök *et al.*, 2000; 2003; Sandvol *et al.*, 2003] reveal that the mantle lithosphere is either very thin or absent beneath a considerable portion of the region between the Aras river (broadly corresponding to the southern border of the EKP) in the north and the Bitlis-Poturge Massif in the south ([Fig. 12](#)). Moreover, crustal thicknesses obtained from receiver function studies indicate a gradual change from < 38 km in the southeast around the southern part of the Bitlis suture zone to 50 km in the north beneath the Erzurum-Kars Plateau [Zor *et al.*, 2003], averaging some 45 km. This indicates that an almost normal-thickness crust overlies an extremely thin mantle lithosphere or perhaps it directly overlies the asthenosphere (see also the cross section in [Fig. 8](#)).

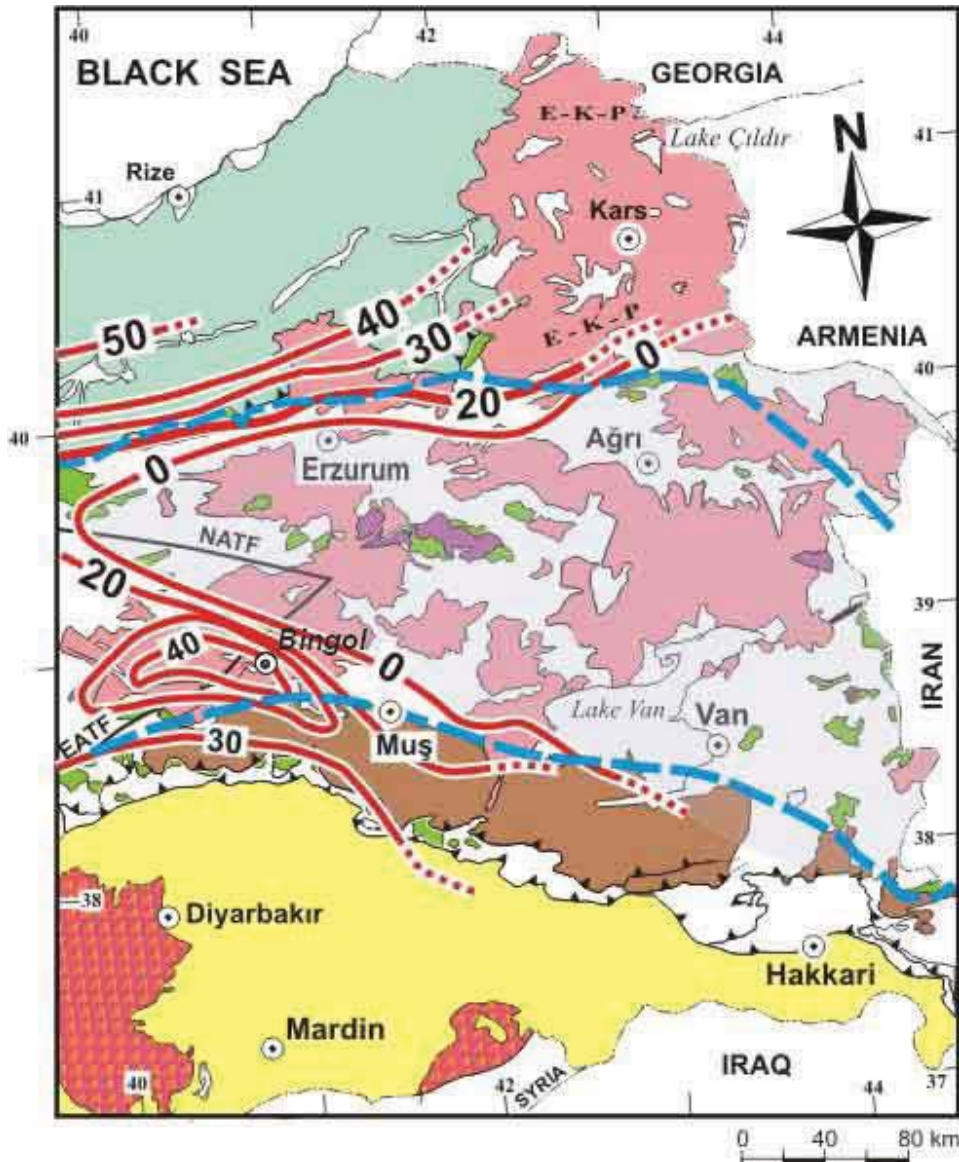

Figure 12. Contours (red) displaying the mantle lid (i.e. lithospheric mantle) thicknesses in km (contours are taken from Fig. 2 of Sengor *et al.*, 2003). The light bluish-coloured triangular area surrounded by the cities of Agri, Erzurum, Bingol and Van in the centre of the figure represents the area with no mantle lid. Thick, dotted dark-blue lines represent the northern and southern borders of the Eastern Anatolian Accretionary Complex (also see Fig. 5). Note that areas of inferred complete lithospheric detachment almost exactly coincide with the extent of the Eastern Anatolian Accretionary Complex (i.e. the EAAC).

These results are also consistent with the study of Hearn & Ni [1994], Maggi *et al.* [2002] and Maggi & Priestley [2005], suggesting that the temperature of the mantle significantly increased beneath this area. What all these findings may imply is that a huge portion of the mantle lithosphere was lost beneath Eastern Anatolia. As the collision-related volcanic activity is almost coeval with the rapid regional block uplift at ~ 11–13 Ma, catastrophic delamination might have been responsible [Keskin *et al.*, 1998].

### 3. Geochemical characteristics of the collision-related volcanic units

One of the most striking aspects of Eastern Anatolia is the volume and the compositional variability of collision-related volcanic products erupted during the Neogene and Quaternary. Over half of the region is covered with young volcanic units (Figs. 4, 5 and 6), exceeding 1 km in thickness in places and ranging in age from 11 Ma to present (Figs. 7 and 8).

### 3.1. Classification

Collision-related volcanic rocks across the region span the whole compositional range from basalts to rhyolites. There is significant variation in lava chemistry in the N-S direction between the Erzurum-Kars Plateau (EKP) in the north and the Mus-Nemrut-Tendurek volcanoes in the south (Figs. 13 and 14). Volcanic units of the Erzurum-Kars Plateau are calc-alkaline (they follow a calc-alkaline trend on the AFM diagram, which is not shown here), while those of the Mus-Nemrut-Tendurek volcanoes are alkaline to mildly alkaline in character. Lavas of the Bingöl and Süphan volcanoes display transitional chemical characteristics [Pearce *et al.*, 1990].

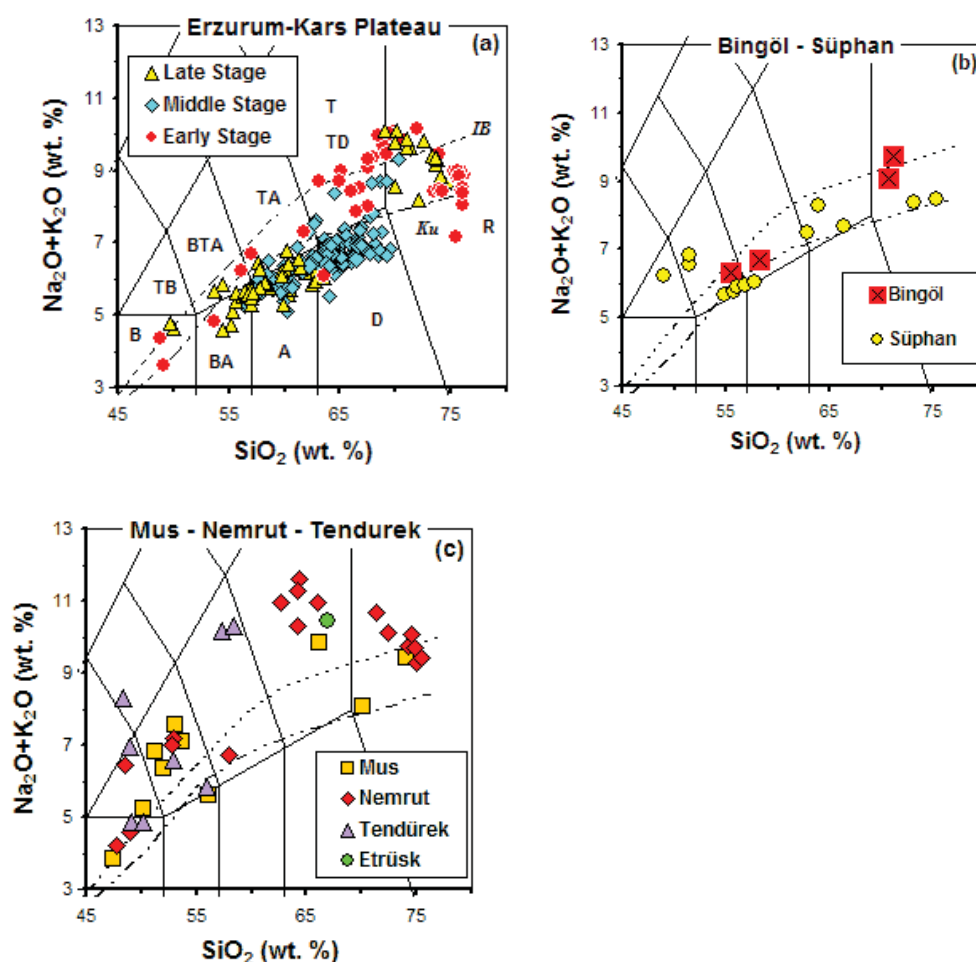

Figure 13. Classification of volcanic units of the Eastern Anatolia region on the total alkali vs silica diagram of Le Bas *et al.* [1986]. Data for Erzurum-Kars Plateau are from Keskin *et al.* [1998], the rest are taken from Pearce *et al.* [1990]. Diagrams are arranged from north to south:

- a. Erzurum-Kars plateau in the north,
- b. Bingöl-Süphan areas in the central-west,
- c. Mus-Nemrut-Tendurek areas in the south.

Abbreviations: B: basalt, BA: basaltic andesite, TB: trachybasalt, BTA: basaltic trachyandesite, A: andesite, TA: trachyandesite, D: dacite, TD: trachydacite, T: trachite, R: rhyolite, IB: alkaline/subalkaline divide of Irvine and Baragar [1971], Ku: alkaline/sub-alkaline divide of Kuno [1966]. Note that alkalinity increases from north to the south.

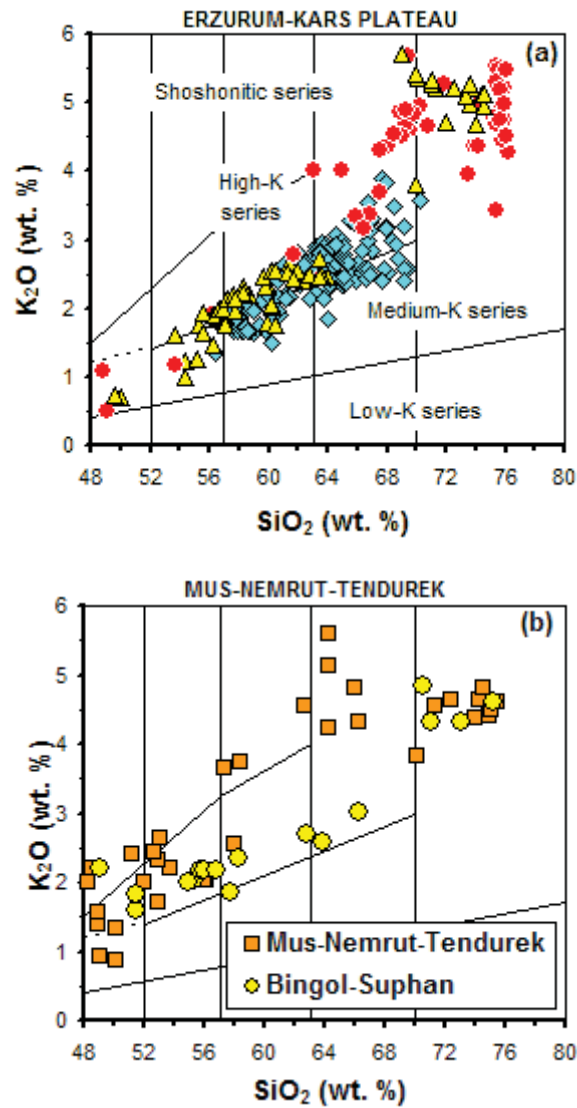

Figure 14. Classification of the volcanic units of the Eastern Anatolia region on the  $K_2O$  vs silica diagram of Peccerillo & Taylor [1976]. Data for Erzurum-Kars Plateau are from Keskin *et al.* [1998] and the rest are from Pearce *et al.* [1990].

### 3.2. Multi-element patterns

Calc-alkaline volcanic units on the EKP and Mt. Ararat display MORB-normalised patterns typical of continental arc volcanics. They are likely to have been derived from an enriched mantle source containing a distinct subduction signature (SC) (Figs. 15 and 16). This signature decreases to the south and diminishes around Mus-Nemrut-Tendurek volcanoes (Figs. 16 and 8), where the lavas are alkaline and display an intraplate signature [Pearce *et al.*, 1990].

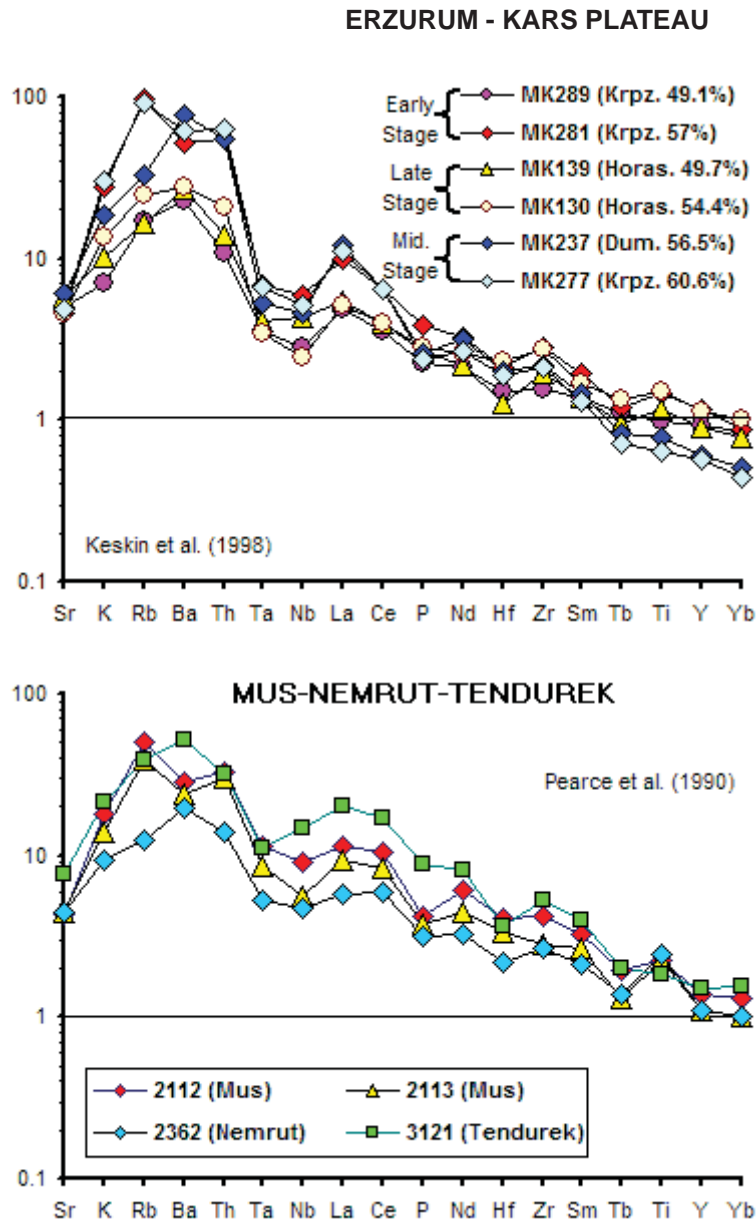

Figure 15. MORB-normalised patterns for volcanic samples from the Eastern Anatolia collision zone. Normalisation values are from Sun & McDonough (1989). The data from the Erzurum-Kars Plateau are taken from Keskin et al. [1998], while the data from the Mus-Nemrut-Tendurek areas are obtained from Pearce et al. [1990].

Numbers in brackets are SiO<sub>2</sub> wt. % values.

Note that the samples from the Erzurum-Kars Plateau in the north contain a distinct subduction signature, while lavas of the Mus-Nemrut-Tendurek areas display an intraplate signature with or without a slight subduction signature.

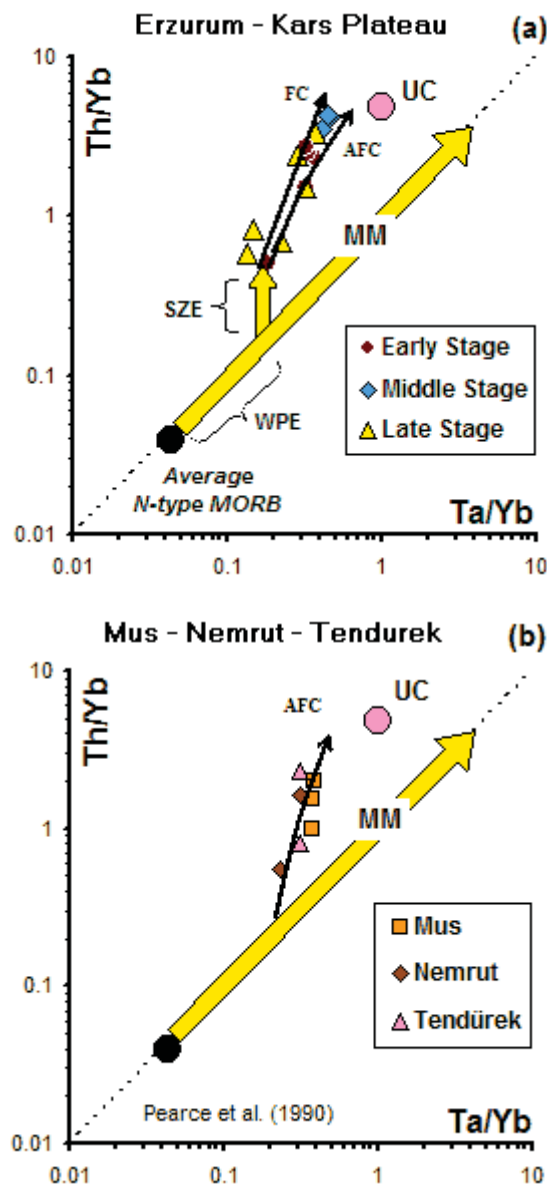

Figure 16. Th/Yb vs. Ta/Yb diagram [after Pearce, 1983] for basic and intermediate lavas ( $\text{SiO}_2 < 60\%$ ) from the Eastern Anatolia Collision Zone. Data from the Mus-Nemrut-Tendurek volcanoes are from Pearce et al. [1990]. MM: mantle metasomatism array; SZE: subduction zone enrichment; WPE: within-plate enrichment; UC: upper crustal composition of Taylor & McLennan [1985]; FC: fractional crystallisation vector; AFC: assimilation combined with fractional crystallisation curve. The FC curve has been modelled for 50% crystallisation of an assemblage consisting of 50% plagioclase and 50% amphibole from a basic magma. The AFC vector has been drawn for an "r" value of 0.3. Note that lavas of the Erzurum-Kars Plateau contain a distinct subduction zone enrichment (SZE) signature.

### 3.3. Petrologic modelling

#### 3.3.1. Modelling of source-enrichment

On a Ta/Yb vs. Th/Yb diagram, calc-alkaline lavas of the Erzurum-Kars Plateau display a consistent displacement from the mantle metasomatism array towards higher Th/Yb ratios, forming a sub-parallel trend to the main MM array (Fig. 16a). This suggests that there was a contribution of a subduction component to the EKP mantle source region. The alkaline basic lavas of the Mus-Nemrut-Tendurek volcanoes show a progressive shift from the MM array with increasing  $\text{SiO}_2$



(Fig. 16b). This implies that these lavas might have been derived from an enriched source with or without a slight subduction signature and then evolved through combined assimilation-fractional crystallisation (AFC).

### 3.3.2. Modelling fractional crystallisation

Crystallization assemblages in the collision-related lavas of the Eastern Anatolia region also display variations across the region. Lavas in the north contain hydrous assemblages (e.g., amphibole) as well as anhydrous minerals, whereas those in the south are dominated by anhydrous minerals. This indicates that lavas are richer in water in the north than in the south, consistent with their subduction signature. Geochemical data are also consistent with these petrographic observations: the lavas containing hydrous minerals (e.g., amphiboles) display distinct depletion with increasing Rb (Fig. 17a) in contrast to the lavas of the southern areas (i.e. Mus-Nemrut-Tendurek; Fig. 17b) which contain anhydrous minerals that exhibit positive to flat gradients [Pearce et al., 1990].

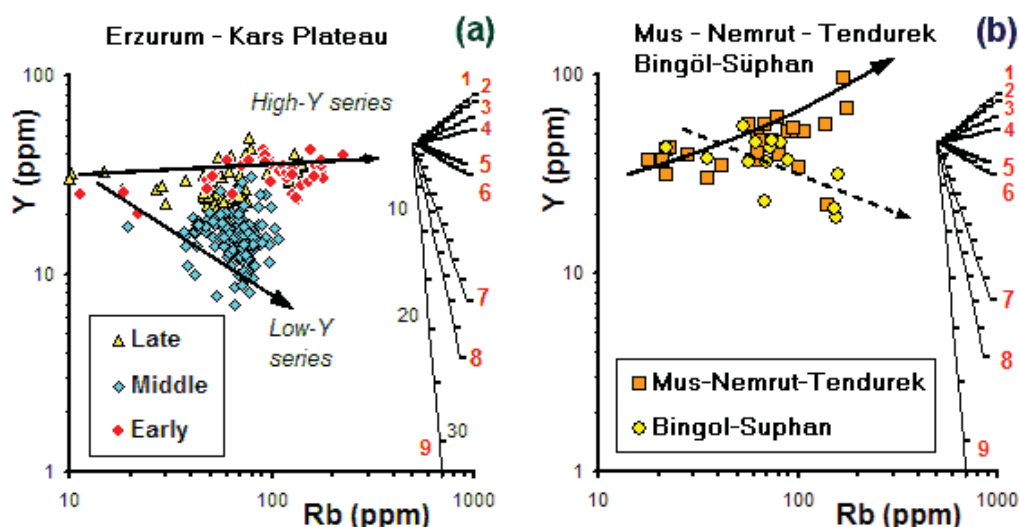

Figure 17. Rb vs. Y diagram displaying theoretical Rayleigh fractionation vectors for 50% crystallisation of the phase combinations (given below) from a common magma composition. Tick marks on each vector correspond to 5% crystallisation intervals. The data for the Erzurum-Kars Plateau are from Keskin et al. [1998], while those from the Mus-Nemrut-Tendurek and Bingöl-Süphan volcanoes in the south are from Pearce et al. [1990]. Bulk partition coefficient values used in the modelling are those given in Table 2 of Keskin et al. [1998]. The FC vectors have been modelled using the “FC-Modeler program” of Keskin [2002].

Phase combinations for the vectors:

1.  $plg_5 + cpx_3 + olv_2$  (B); 2.  $plg_5 + cpx_5$  (B) or  $-plg_5 + cpx_3 + olv_2$  (I); 3.  $plg_5 + amp_5$  (B) or  $plg_5 + cpx_5$  (I)
4.  $plg_2 + opx_1 + cpx_6 + olv_1$  (I); 5.  $plg_5 + cpx_5$  (A); 6.  $plg_5 + amp_5$  (I); 7.  $plg_4 + amp_4 + gt_2$  (I); 8.  $plg_5 + amp_5$  (A); 9.  $plg_4 + amp_4 + gt_2$  (A).

*plg*: plagioclase, *cpx*: clinopyroxene, *opx*: orthopyroxene, *olv*: olivine, *amp*: amphibole, *gt*: garnet  
B: basic, I: intermediate, and A: acid magma compositions.

### 3.3.3. Modelling AFC process

AFC modelling results indicate that the degree of magma-crust interaction is larger in the south than in the north (Fig. 18). Radiometric dating results indicate that volcanic activity began earlier in the north than in the south, migrating south over time (Figs. 7 and 8).

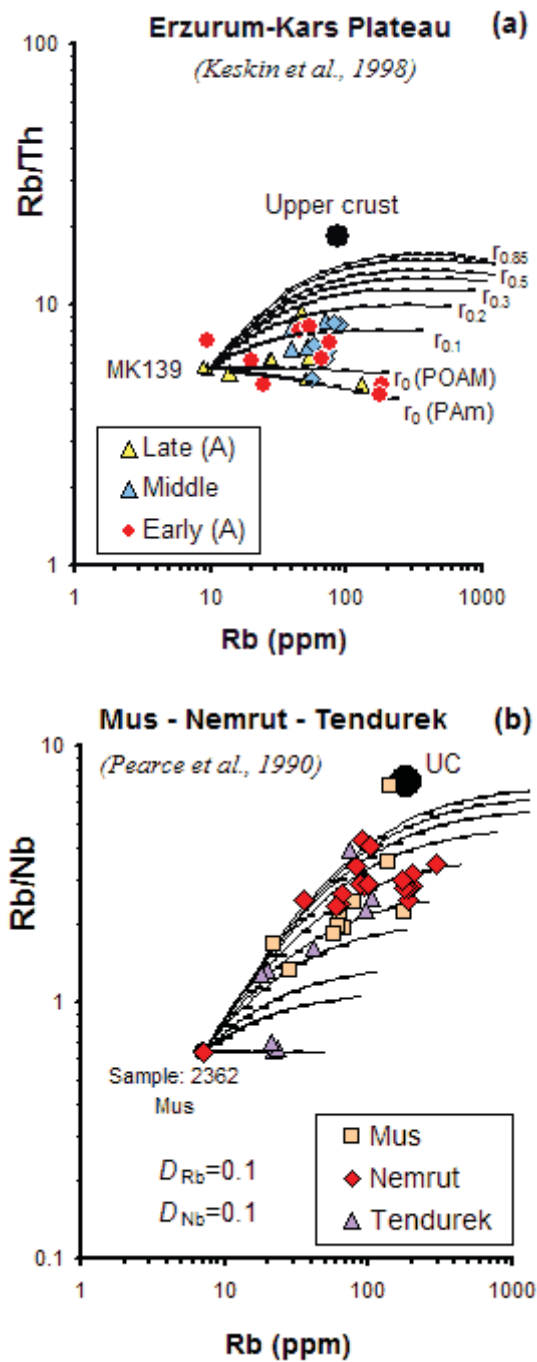

Figure 18. Diagrams showing the results of assimilation-fractional crystallisation (AFC) modelling. The modelling was conducted using the AFC equations of De Paolo [1981]. Bulk partition coefficients are inset in the diagrams. Parental magma compositions correspond to the basaltic sample MK139 (Erzurum-Kars Plateau; Keskin et al., 1998) and sample 2362 (Mus-Nemrut-Tendurek; Pearce et al., 1990), and the average crustal composition of Taylor & McLennan [1985].

### 3.3.4. Modelling partial melting process

Melting modelling (Fig. 19) was carried out using the fractional and batch melting equations of Shaw [1970], the bulk partition coefficient values given in the inset of Fig. 19 (for the source of  $K_d$  values, see the caption of Fig. 19) and modal mineralogy of spinel- and garnet-peridotites proposed by Wilson [1989] (see the caption of Fig. 19). The trace element composition of the garnet-peridotite is taken from Frey [1980], while the composition of the spinel-peridotite is the

average composition of spinel peridotite xenoliths (see  $C_0$  values in the inset of Fig. 19) in young (*i.e.*, Miocene-Pliocene) alkaline basalts from the Thrace region, NW Turkey [Esenli & Genc, submitted]. Most of the lavas of the EKP plot on the batch-melting curve of the spinel peridotite, while two of them (MK144: the oldest, 11 Ma, sample from the bottom of the Horasan area, and three lava samples from the Middle Stage in the Dumlu area) fall close to the beginning of the fractional melting curve. Therefore, magmas that fed the volcanism on the Erzurum-Kars Plateau seem to have been generated by partial batch melting of a spinel peridotite mantle source. The degree of melting might be quite high for the lavas clustering around the end of the batch-melting curve.

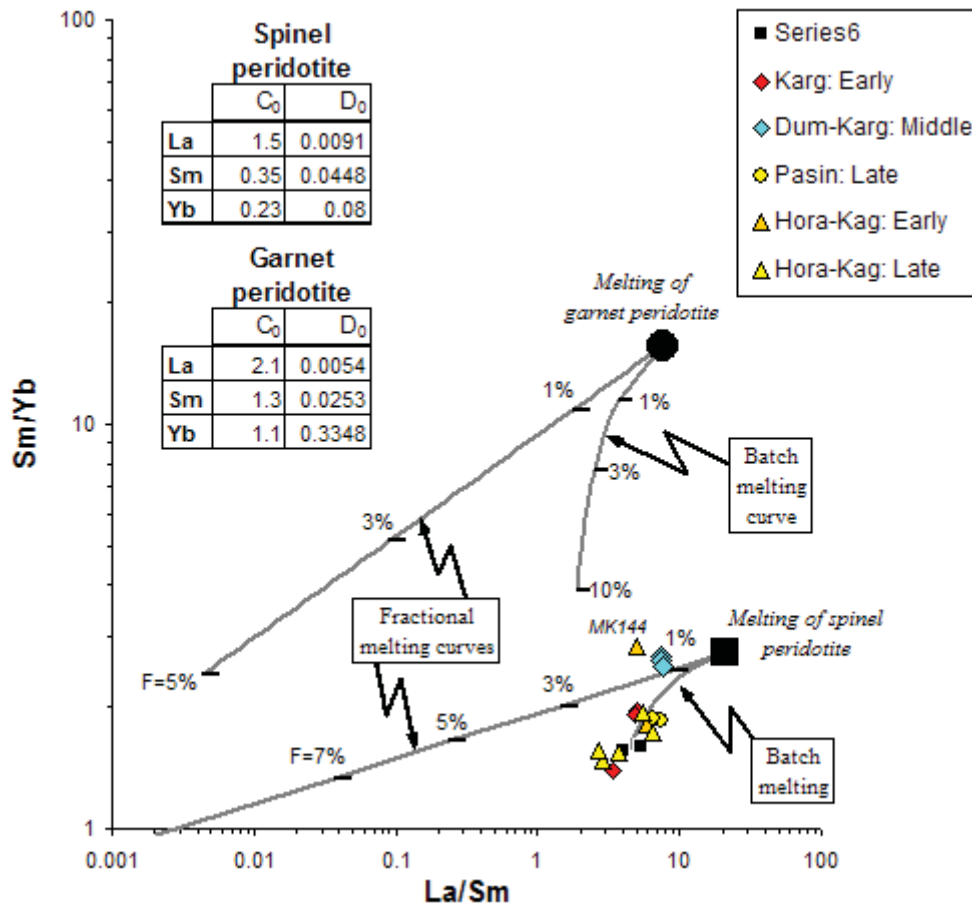

Figure 19.  $La/Sm$  vs.  $Sm/Yb$  plot showing theoretical melting curves plotted along with the basic samples ( $SiO_2 < 57\%$ ) from the Erzurum-Kars Plateau. Fractional and batch melting equations of Shaw [1970] were used to construct the melting model.  $F$ : weight fraction of melt produced.

Modal mineralogy for the spinel- and garnet-peridotites are taken from Wilson [1989], and  $ol_{.66} + opx_{.24} + cpx_{.08} + sp_{.02}$  and  $ol_{.63} + opx_{.30} + cpx_{.02} + gt_{.05}$  respectively (*ol*: olivine, *opx*: orthopyroxene, *cpx*: clinopyroxene, *sp*: spinel, *gt*: garnet). Trace element composition of the spinel-peridotite ( $C_0$  values) is the average composition of spinel peridotite xenoliths in young (Miocene) alkaline basalts of the Thrace region, NW Turkey [Esenli & Genc, submitted], while that of garnet peridotite is from Frey [1980].  $K_d$ s between the basaltic melts and minerals given in the inset are compiled from Irving & Frey [1978], Fujimaki et al. [1984], McKenzie & O'Nions [1991] and Rollinson [1993]. Bulk partition coefficient ( $D_s$ ) of each element has been calculated for garnet and spinel peridotite source rock compositions by taking the modal mineralogy of these end members into consideration. The coefficients are given in the inset.

Coherence of the data points from different stages of the volcanism in Fig. 19 indicates that the nature of the mantle source and the mode of the melting process varied little with time. This is also consistent with the results obtained from chondrite-normalized REE and MORB-normalized multi-element patterns (see Fig. 15); basic lavas erupted during the early and late stages display similar

patterns all over the EKP. Similar modelling was conducted for the lavas of the Karacadag and Tendurek volcanoes in the south by *Sen et al.* [2004], and produced similar results.

### 3.4. Summary of the geophysical and geochemical findings

The geochemical and geophysical findings are presented together in the cross section in [Fig. 8](#). The geochemical evidence presented so far indicates that volcanic products in the north around the EKP and Mt. Ararat are calc-alkaline in character and likely to have been derived from an enriched mantle source containing a distinct subduction signature ([Fig. 8](#)). This signature decreases to the south and diminishes around the Mus-Nemrut-Tendurek volcanoes, where the lavas are alkaline and display an intraplate signature. Results from AFC modelling show that the degree of magma-crust interaction is larger in the south than in the north ([Fig. 18](#)). Radiometric dating results indicate that volcanic activity began earlier in the north than in the south, and migrated south over time ([Fig. 7](#)).

The striking results of the **Eastern Turkey Seismic Experiment** project along with the geochemical findings discussed above lead us to question the validity of geodynamic models proposed for the Eastern Anatolian Collision Zone in a number of studies reported in the literature. Therefore, prior to focusing on the issue of what process was responsible for the loss of mantle lithosphere, I first review the competing geodynamic models and their discrepancies.

## 4. Competing geodynamic models & their discrepancies

Ten different geodynamic models have been proposed for the genesis of collision-related magmatism beneath the Eastern Anatolian collision zone.

Some of the earlier studies [e.g., the tectonic escape model of *McKenzie*, 1972, and the lithospheric thickening model of *Dewey et al.*, 1986] did not address the problem of why and how huge volumes of magmas were generated beneath the region. Any geodynamic model proposed for the Eastern Anatolian collision zone should, however, answer this critical question since the topographic expression, tectonic elements and magma generation are clearly all associated with the same mechanism.

There appear to be inconsistencies in all models except for the delamination and the slab-steepening & breakoff models. In what follows, each model is discussed thoroughly with its weaknesses and strengths.

### 1. The tectonic escape of micro-plates to the east and west [*McKenzie*, 1972].

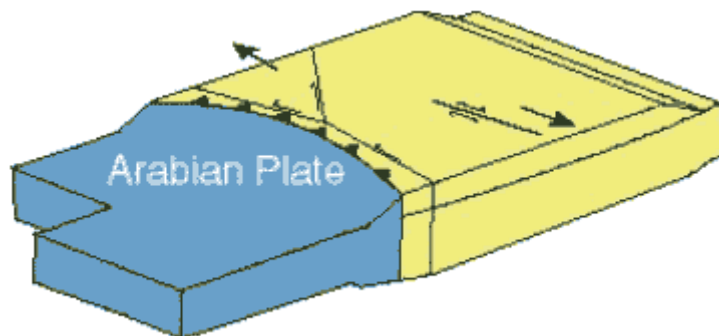

Figure 20

**Discrepancies:** A close examination of the model of *McKenzie* [1972] reveals that it does not account entirely for the strain induced by the 2.5 cm/yr convergence of the Arabian and Eurasian plates [*Dewey et al.*, 1986]. In addition, this model cannot explain why and how huge volumes of magma were generated beneath the region and how the region was elevated to form an extensive plateau now 2 km above sea level. It also does not provide an answer to why the lithospheric mantle is absent beneath a greater portion of Eastern Anatolia.

**2. Renewed subduction of the Arabian plate beneath the Pontides and Eastern Anatolia [Rotstein & Kafka, 1982].**

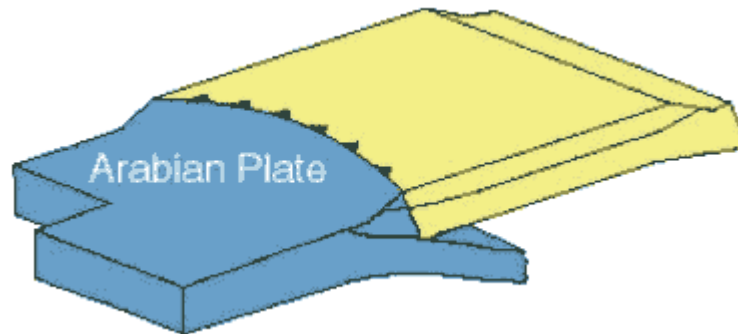
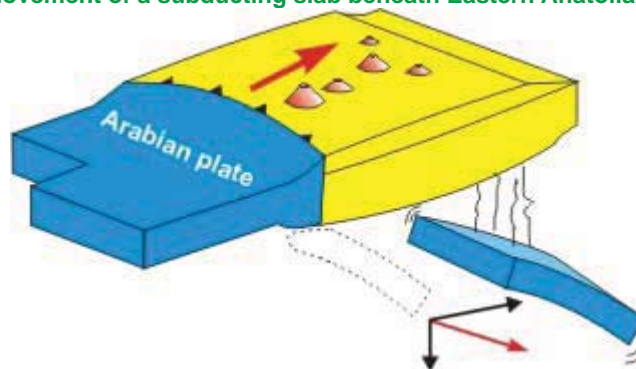

Figure 21

**Discrepancies:** this model is not supported by any seismic evidence. There are no seismic data for a north-dipping Benioff zone beneath the Eastern Anatolia region. Tomographic images obtained from the ETSE project [Al-Lazki *et al.*, 2003] indicate that a slab beneath the region does not exist.

**3. Detachment and northward movement of a subducting slab beneath Eastern Anatolia**



[Innocenti *et al.*, 1982a,b].

Figure 22

On the basis of their dating results and chemical zonation in volcanic units across the collision zone, Innocenti *et al.* [1982a,b] suggested that the andesitic volcanic front migrated northward by 150-200 km during the Pliocene. According to them, this is evidence for detachment of the subducted slab immediately after continental collision. According to their model, the detached slab moved northward while it was sinking in the asthenosphere. They suggest that this movement generated progressively lower intensity magmatism from south to the north. In their view, volcanism becomes younger from south to north. In this model, calc-alkaline magmas that formed the Plio-Quaternary volcanic belt in the north were generated above the subducting slab, while the alkaline magmas representing the Miocene volcanic belt in the south were derived from the asthenosphere upwelling through the gap behind the detached subducting slab.

Although the model of Innocenti *et al.* [1982a,b] is one of the earliest, it is remarkable in that the possibility of slab detachment and consequential effects in the Eastern Anatolian Collision Zone were envisaged 13 years earlier than the "slab-breakoff model" was proposed by Davies & von Blanckenburg [1995]. The latest geodynamic model, "slab-steepening & breakoff beneath a large subduction-accretion complex", by Keskin [2003] also proposes a similar slab-detachment process, although the slab in the model of Keskin [2003] does not move northward after breakoff but instead steepens beneath a large subduction-accretion complex until it breaks off, creating a gradually widening mantle wedge beneath the region.

**Discrepancies:** A more detailed study of collision-related volcanism on the Erzurum-Kars Plateau [Keskin, 1994], which comprises the northernmost part of the Eastern Anatolian volcanic province,

has shown that volcanism initiated at ~ 11 Ma in the north [Keskin *et al.*, 1998] and then migrated south over time [Keskin, 2003]. These findings are the opposite of what is proposed by Innocenti *et al.* [1982a,b]. In addition, there is no seismic evidence for a currently subducting slab beneath the region.

**4. Rifting along E-W oriented Late Miocene-Pliocene basins [Tokel, 1985] possibly accompanied by decompression melting of “normal asthenosphere” due to extension [McKenzie & Bickle, 1988].**

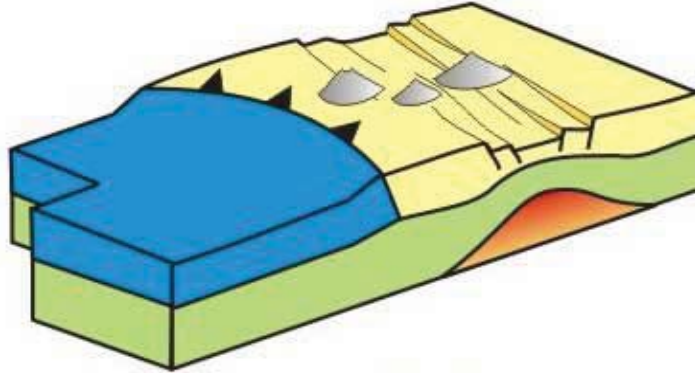

Figure 23

Tokel [1985] cited data from drilling cores gathered from E-W oriented Upper Miocene-Pliocene basins in Eastern Anatolia. He argued that these basins are bounded by gravity faults and are filled with at least 2000 m of limnic and fluvial deposits intercalated with voluminous “tholeiitic” and “alkaline” volcanic products. He suggested that recent tectonics in Eastern Anatolia were dominated by an extensional stress regime. On the basis of the mathematical model of Turcotte [1983], he proposed that these depressions and the sediments deposited therein were related to a “rifting event” in the region.

**Discrepancies:** The fault plane solutions of earthquakes in the region indicate that the faults are either strike slip or reverse, which is inconsistent with extension (*i.e.* a rift setting). A close examination of the E-W oriented basins in the region reveals that they are not rift-related but are, instead, dominantly pull-apart basins related to strike slip fault systems.

Decompression melting of normal asthenosphere as a result of regional extension [McKenzie & Bickle, 1988] requires a stretching factor of about 2.5 to generate melts in dry asthenosphere at a depth of 50 km and a temperature of around 1280°C. As is well known the region is not being stretched so at first sight this does not seem to be a likely scenario. However, it is now almost certain that nearly all the mantle lithosphere was detached from beneath the region and thus, at present, the lithosphere is much thinner than normal (~ 38-50 km). Even if this is the case, however, it is theoretically difficult to melt dry asthenosphere in the absence of extension. The asthenospheric mantle beneath the region is not completely dry, but instead it contains a distinct subduction component which increases in importance from south to north as deduced from the chemistry of collision-related volcanics in the region [Pearce *et al.*, 1990; Keskin, 1998]. The existence of a subduction component (with water) in the asthenospheric mantle may thus significantly decrease the melting temperature and permit the generation of voluminous basic magma at this depth (38 to 45 km).

**5. Continental collision and subsequent thickening of the Anatolian crust/lithosphere [Dewey *et al.*, 1986].**

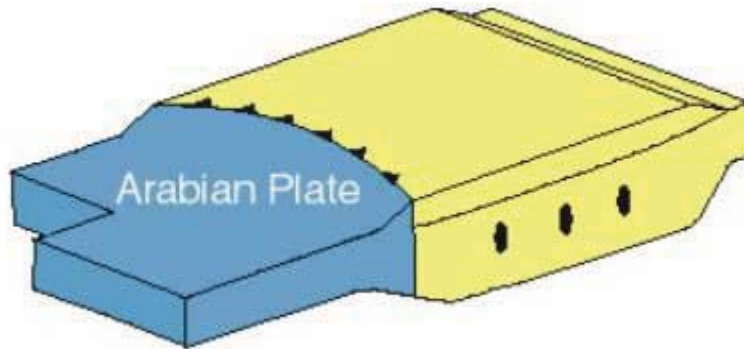

Figure 24

Dewey *et al.* [1986] argued that the Eastern Anatolia region owes its high elevation to a doubled (~ 300 km) lithospheric thickness. According to them, this thickening occurred as a result of continental collision between the Arabian and Eurasian continents. They also point out that the lavas were erupted through both N-S cracks that extend into the Arabian foreland and through transcurrent pull-aparts. In this model magma generation is linked to local extension and small-scale delamination events beneath the pull-apart basins (e.g., the Erzincan, Karasu-Pasinler-Horasan and Mus basins).

Following the model of Dewey *et al.* [1986], Yilmaz *et al.* [1987] suggested that the young volcanism in Eastern Anatolia could be linked to heating of the lower continental crust and mantle lithosphere which had been subjected to lithospheric thickening. Similarly, on the basis of their geochemical data, Koronovskiy & Demina [1996] argued that heating due to crustal thickening may explain the young volcanism of the Lesser Caucasus, adjacent to the Eastern Anatolia region.

**Discrepancies:** It is now well understood that the region would not have been isostatically elevated to ~ 2 km if a 250-300 km thick and dense (3.2-3.3 g/cm<sup>3</sup>) mantle lithosphere had been attached to the base of a lighter (2.7-2.8 gr/cm<sup>3</sup>) crust [Sengor *et al.*, 2002; Sengor *et al.*, 2003]. The model is not supported by recent tomographic data either [e.g., Al-Lazki *et al.*, 2003; Gok *et al.*, 2003]. Results of the **Eastern Turkey Seismic Experiment** project indicate that mantle lithosphere beneath the region is very thin or completely absent over a great distance in the middle of the region (Fig. 8).

Collision-related volcanic units are not confined to pull-apart basins. Instead, they cover a much greater area away from these basins. This indicates that volcanism in the region cannot be explained by the pull-apart model alone.

Pearce *et al.* [1990] discuss the point that a 50% increase in thickness of the metasomatised mantle lithosphere lowers a significant portion of this layer to a depth below that of amphibole breakdown, forming garnet and releasing water. This may initiate localised melting but it also lowers the geotherm. When this happens, most of the metasomatised layer remains significantly below the solidus and thus does not produce magma [Pearce *et al.*, 1990]. Therefore, it is difficult to explain the huge volumes of magma generated in the region by the models of Yilmaz *et al.* [1987] and Koronovskiy & Demina [1996].

6. Hot spot activity related to a mantle plume [discussed by Pearce *et al.*, 1990].

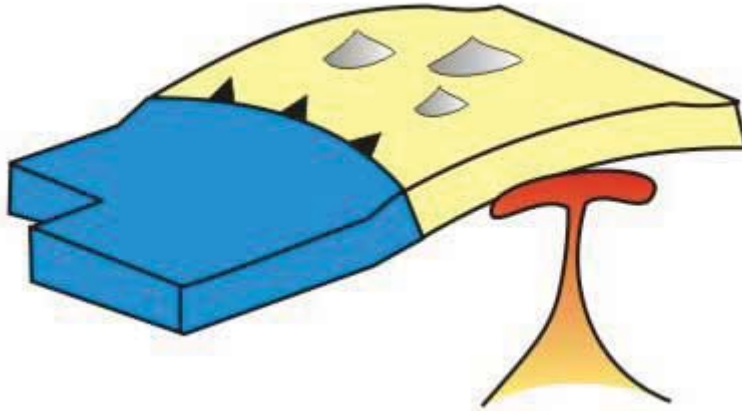

Figure 25

The possibility of plume-related “hot spot” activity in Eastern Anatolia was previously discussed by Pearce *et al.* [1990]. They point out that the remarkable correlation between topographic and volcanic expressions in Eastern Anatolia. The Eastern Anatolia topographic uplift has an asymmetric (*i.e.* deformed) dome shape [Sengor *et al.*, 2003] whose long-axis aligns approximately E-W. The overall volcanic expression is also asymmetric, extending about 300 km in the direction of compression but 900 km perpendicular to it [Pearce *et al.*, 1990]. This remarkable correlation between the topography and volcanic expression brings into question whether there is a mantle plume beneath the Eastern Anatolia Collision Zone.

Sengor *et al.* [2003] compared the E-W topographic profile of the *Eastern Anatolian Plateau* along the 40° parallel with the plume-generated *Ethiopian High Plateau* [Sengor, 2001] and found a striking similarity between them (Fig. 11). They low-pass filtered both profiles at 125 km to remove plastic effects. On the basis of the similarity of the profiles, they argued that the cause of the domal uplift in both regions was the same: hot, rising asthenosphere beneath crust bereft of underlying mantle lithosphere [Sengor *et al.*, 2003].

Although domal uplift related to a mantle plume is expected to have a symmetrical shape, in theory, it may acquire an asymmetrical shape in a collision setting due to compression. However, there is no modern or ancient example anywhere in the world of a plume-related dome structure deformed by shortening in a collision zone.

**Discrepancies:** Dome structures formed by plumes are expected to contain fault systems and dyke swarms distributed radially. Such faults and dykes are absent in Eastern Anatolia. Fault plane solutions of earthquakes imply that the faults are either transform or reverse; not normal as would be expected in a plume-related domal structure. A plume model cannot explain why volcanic units contain a distinct subduction component in the north of Eastern Anatolia, and why this component gradually diminishes to the south. It is also difficult to explain by a plume model why volcanism migrated south with time, and why there is a gradual change in magma chemistry from calc-alkaline in the north to alkaline in the south. As pointed out by Pearce *et al.* [1990], volcanic activity over the last 6 Myr displays a temporal change from more regional-scale activity to localised activity on a set of aligned central volcanoes. Such an evolutionary sequence is the reverse of what is expected in plume-related volcanic activity.

On the basis of these discrepancies, I argue that a plume setting is not a viable model for the Eastern Anatolian Collision Zone.



7. Delamination of mantle lithosphere beneath the region [Pearce et al., 1990; Keskin et al., 1998].

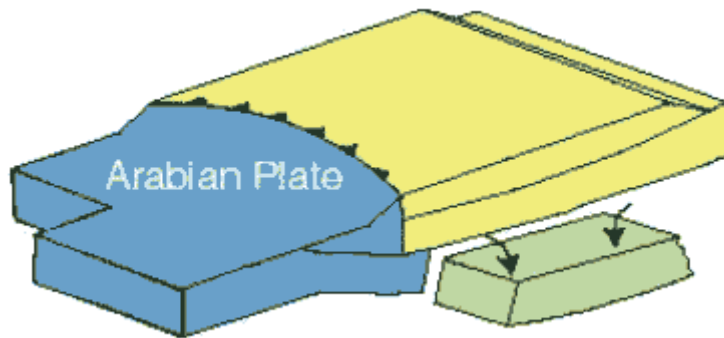
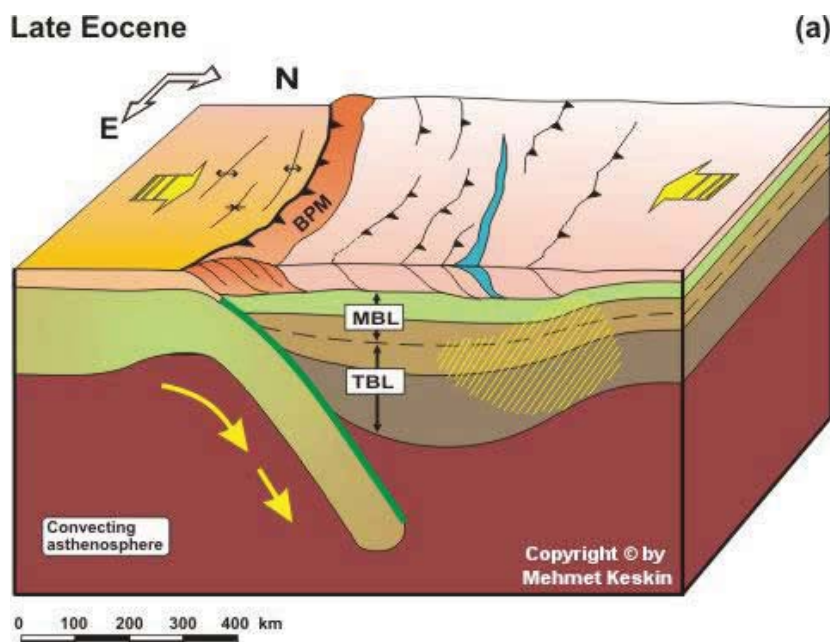
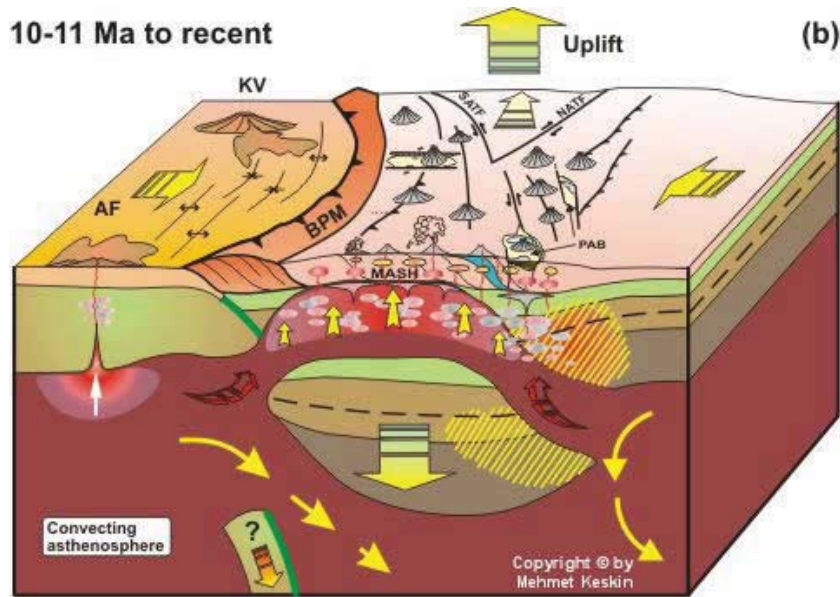

Figure 26

Delamination of a thickened thermal boundary layer is plausible since it is colder and hence denser than the underlying asthenosphere [Ed: See also [Lithospheric Delamination](#) page]. It could therefore be convectively replaced by asthenosphere [Houseman et al., 1981; England & Houseman, 1988]. Platt & England [1993] argue that magmatism in mountain belts could be evidence of delamination of the lower part of the thickened mantle lithosphere. Figs. 27a and b illustrate the delamination model in a three-dimensional block diagram for the Eastern Anatolia region [modified from Keskin, 1994]. This process is likely to be an effective mechanism for generating large volumes of collision-related magma across the region, since asthenosphere is brought into close contact with the thickened layer of metasomatised lithosphere [Pearce et al., 1990]. When delamination occurs, it causes a perturbation in what is left of the mantle lithosphere, raising some parts of it above its solidus. While sinking into the asthenosphere, the delaminated block of the mantle lithosphere may release water that also promotes melting. These two mechanisms play an important role in the generation of extensive partial melting in the mantle, and can produce widespread volcanism in the region (Fig. 27b).

Pearce et al. [1990] argue that the region is characterised by a set of mantle domains that run parallel to the collision zone. They suggest that each domain has yielded magmas of particular composition since the beginning of the magmatism in the region. This may also be regarded as supporting evidence for the delamination model.





EXPLANATIONS

Continental crust of Arabian foreland	Garnet peridotite	Volcanoes
Thickened continental crust of Eastern Anatolia	Metasomatised lithosphere Phlogopite, carbonate, garnet peridotite	Thrusts
Cretaceous -Eocene ophiolitic suture	LIL element enriched lithosphere due to metasomatism created by Cretaceous Eocene arc volcanism.	Strike-slip faults
Lithospheric mantle of the Arabian continent	Partial melting zone in metasomatised sub-continental lithosphere	Crustal magma chambers (Red: deep, yellow: shallow).
Oceanic crust	Garnet peridotite	
	Convecting asthenosphere	

Figure 27. Block diagrams illustrating the delamination model for the Eastern Anatolian Collision Zone. Modified from Keskin [1994].

On the basis of estimates of the active slip rates, total convergence and timing of collision-related deformation across the Arabia-Eurasia collision zone, coupled with the interpretation of a cross-section produced by the *National Iranian Oil Company* [1977], *Allen et al.* [2004] suggest that the collision-related magmatism, which initiated at ~ 11 Ma [Keskin et al., 1998] pre-dates shortening of the crust in the region. Therefore, they argue, a sudden and regional delamination event is not a viable model. However, results obtained from two independent seismic studies:

1. the **Eastern Turkey Seismic Experiment** Project [Al-Lazki et al., 2003; Gök et al., 2000; 2003; Sandvol et al., 2003] and
2. the Surface Waveform Tomography study of Maggi & Priestley [2005]

reveal that most of the Eastern Anatolian Collision Zone is devoid of a mantle lithosphere. Therefore, geophysical findings support a major lithospheric detachment beneath the region and contradict the interpretation of *Allen et al.* [2004].

**Discrepancies:** As discussed in Section 2, new data obtained from the **Eastern Turkey Seismic Experiment** indicate that there appears to be no lithospheric mantle over a greater portion of the area beneath the region. If this is the case, then the delamination must have been

a shallow event involving the whole lithospheric mantle and perhaps even the lower crust. In the absence of metasomatised lithospheric mantle, the source region would then be asthenospheric mantle.

*Sengor et al.* [2003] point out that the basement of a great portion of the Eastern Anatolia Region between the Aras River in the north and Lake Van in the south is represented by a subduction-accretion complex (*i.e.* EAAC in [Fig. 12](#)). This area also coincides with the area under which a lithospheric mantle lid is missing [*Sengor et al.*, 2003]. In contrast to continental blocks, large subduction-accretion complexes are devoid of their own lithospheric roots, as they are produced on, and supported by, subducting oceanic slabs. Therefore, in theory, this area should have been underlain by a subducting slab, not by sub-continental mantle lithosphere, before the lithospheric detachment event.

As the delamination process requires the presence of mantle lithosphere, what took place beneath the region could not have been a delamination event. As tomography provides no evidence for a mantle lid beneath the region, then the underlying slab must have detached and sunk into the asthenosphere possibly immediately prior to the domal uplift of the region at ~ 13 Ma. In view of these arguments, a model involving steepening and breakoff of a subducting slab beneath a huge subduction-accretion complex can explain better the geodynamic evolution of the Eastern Anatolian Collision Zone [*Keskin*, 2003; *Sengor et al.*, 2003]. As discussed below, this model is not only consistent with the geology of the region but also explains better the variations in magma age and chemistry across the region ([Fig. 8](#)).

#### 8. Localized extension associated with pull-apart basins in strike-slip systems [*Pearce et al.*, 1990; *Keskin et al.*, 1998].

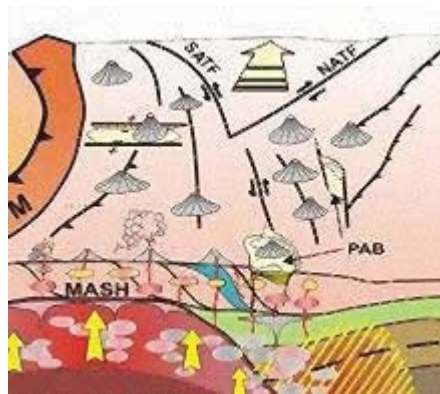

Figure 28

In their pioneering study, *Dewey et al.* [1986] highlighted the connection between the formation of pull-apart basins and volcanism. They pointed out that there are two different neotectonic magmatic suites in the region:

1. the nepheline-hypersthene normative alkaline basalts of mantle origin, and
2. the silicic-to-mafic calc-alkaline suite.

They suggested that both suites occur in pull-apart basins in strike slip regimes and N-S extensional fissures. They argue that the position and shape of magmatic intrusions might have been controlled by “flaking of the elastic lid” particularly beneath the pull-apart basins. They argue that rapid lithospheric stretching and small-scale delamination beneath pull-apart basins can generate melting in the mantle.

Although *Pearce et al.* [1990] consider delamination to be the dominant process that caused voluminous magma generation beneath the region, they also argue that it might have been accompanied by other stretching mechanisms, such as the creation of pull-apart basins. They also suggested that deviatoric stress perpendicular to the principal direction of compression might also have some effect.

*Keskin et al.* [1998] emphasised the role of strike-slip faulting in pull-apart basins in focussing magmas on the Erzurum-Kars Plateau, north of the region. They point out that, compared to nearby areas, a much thicker (2-4 km) sequence of volcanic/volcano-clastic rocks was deposited in these gradually subsiding basins. However, it is not clear whether these faults simply provide fractures that enable magma to reach the surface or whether the associated localised extension in pull-apart basins also encourages melting in the mantle.

More recently *Cooper et al.* [2002] suggested a similar model for the origin of mafic magmas beneath northwestern Tibet and argued that these lavas might have been created by mantle upwelling beneath the releasing bends of the strike-slip fault systems [Ed: see also [Ridge-transform intersections](#) page].

**Discrepancies:** As mentioned the Introduction, collision-related volcanic units in the region are not confined to pull-apart basins, but cover a much greater area. Therefore, it is plausible that a pull-apart model cannot explain the genesis of all the collision-related magmatism in the region. Some other mechanism must also have been operational.

**9. Inflow of lower crust driven by the isostatic response to denudation and sedimentation in surrounding areas [*Mitchell & Westaway, 1999*].**

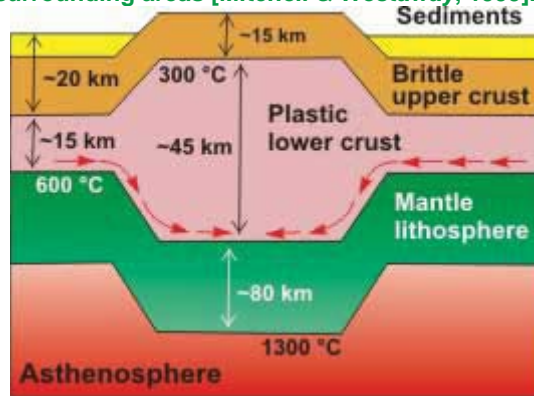

Figure 29

On the basis of their study of Neogene-Quaternary uplift and magmatism in the Greater Caucasus, *Mitchell & Westaway* [1999] proposed an alternative model to explain the formation of high mountain ranges and plateaus such as the Greater and Lesser Caucasus including the Armenian highlands adjacent to Northeastern Anatolia. They argue that the rate and spatial scale of uplift of the Caucasus are too great to be the result of plate convergence alone, and therefore some other processes must have been operational.

*Mitchell & Westaway* [1999] argue that when crustal material is hotter than 300°C, it starts to behave in a ductile way, deforming plastically. The depth at which this temperature is reached (~15-20 km) broadly corresponds to the boundary between the plastic lower crust and the brittle upper crust. In the lower crust, the direction of movement (*i.e.* direction of flow) is determined by pressure gradients caused by lateral variations in the depth of the base of the brittle layer [*Mitchell & Westaway, 1999*]. In this model, most of the crustal deformation occurs in the lower crust in an atectonic fashion [*e.g. Kaufman & Royden, 1994*].

The model of *Mitchell & Westaway* [1999] is dramatically different from the rest of the competing models in that crustal thickening is not caused directly by plate motions. Their model involves lateral inflow of ductile lower crust, driven by the isostatic response to denudation of a mountain range and sedimentation in its surroundings. According to these authors, the start of uplift of the Caucasus and surrounding areas relates to changes in environmental conditions in the Late Miocene. The Messinian drawdown of sea-level in the Mediterranean region resulted in complete desiccation of the Black Sea [*Giavanoli, 1979*]. This was accompanied by drawdown of Caspian sea level. Not only did this result in an increase in subaerial relief, but also in an increase in the denudation rate of the Greater Caucasus. Coupled denudation and sedimentation ([Fig. 29](#)) caused lateral inflow into the lower crust towards the base of the mountain range, resulting in uplift along the length of the Caucasus.

*Mitchell & Westaway* [1999] suggest that atectonic thickening of the continental crust keeping mantle lithosphere thickness constant would raise the temperature in the mantle lithosphere, resulting in melting and magma generation as suggested by *Koronovskiy & Demina* [1996]. They argue that this process was responsible for both uplift and volcanism in the Lesser Caucasus, including Armenia, adjacent to Eastern Anatolia. They also suggest that this process could be a viable model for Eastern Anatolia [*Rob Westaway, personal communication, 2002*].

**Discrepancies:** In the model of *Mitchell & Westaway* [1999], thickening occurs only in the lower crust by means of lateral flow driven by plastic deformation. In such a case, a normal thickness of lithospheric mantle is still expected beneath the thickened crust, as there is no reason why it should have been detached from the base of the crust or along the thermal boundary layer. However, there is strong seismic evidence for a major lithospheric detachment event beneath the region [from the **Eastern Turkey Seismic Experiment Project** *Al-Lazki et al., 2003; Gök et al., 2000; 2003; Sandvol et al., 2003* and the Surface Waveform Tomography study by *Maggi & Priestley, 2005*].

Moreover, as previously discussed, an increase in the thickness of the lithosphere is not able to generate a significant amount of magma, as it remains well below its solidus [*Pearce et al., 1990*]. Therefore, the model of *Mitchell & Westaway* [1999] is not consistent with new geophysical findings and fails to explain the volume and variability of magmatic products across the region.

#### 10. Slab steepening and breakoff beneath a subduction-accretion complex [*Keskin, 2003*].

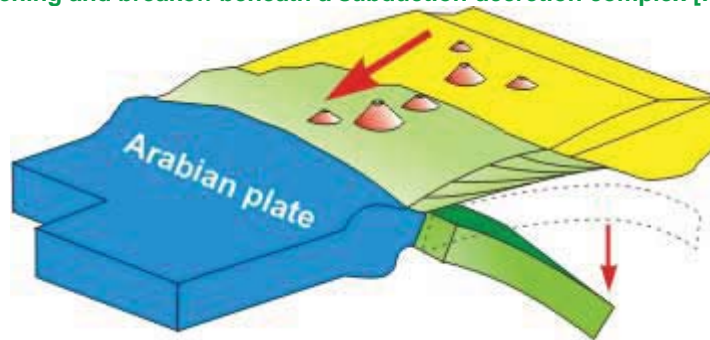

Figure 30

*Sengor et al.* [2003] pointed out that areas with no mantle lithosphere, located in the south of the EKP, coincide broadly with the East Anatolian Accretionary Complex (EAAC), a huge subduction-accretion prism of late Cretaceous to earliest Oligocene age. Following the subduction-accretion hypothesis [*Sengor & Yilmaz, 1981; Sengor & Natal'in, 1996*], *Sengor et al.* [2003] argue that the EAAC can be regarded as a remnant of a large accretionary prism located between the Pontides and the Bitlis-Pötürge Massif, having formed on northward-subducting oceanic lithosphere. Large subduction-accretion complexes are devoid of lithospheric roots; instead they are underlain by subducting slabs [*Sengor et al., 2003*]. Since this was probably the case for the EAAC, then shallow delamination could not be a viable alternative model for collision-related magma generation beneath the aforementioned portion of Eastern Anatolia in the absence of sub-continental lithospheric mantle [*Keskin, 2003; Sengor et al., 2003*]. As a subducting slab is also absent beneath the EAAC, this can be ascribed to the past breakoff of the inferred slab beneath the EAAC ([Figs. 30](#) and [4a,b](#)).

## 5. Discussion

*Keskin* [2003] showed that volcanic activity began earlier in the north than in the south, migrating south with time ([Figs. 7](#) and [8](#)). This migration was accompanied by significant variation in lava chemistry in the N-S direction between the EKP in the north and the Mus-Nemrut-Tendurek volcanoes in the south. As discussed earlier in Section 2, volcanic products erupted in the north around the EKP were calc-alkaline in character with a distinct subduction signature in contrast to the ones in the south around the Mus-Nemrut-Tendurek volcanoes which were alkaline with an intraplate signature [*Pearce et al., 1990*]. The volcanic units of the Bingöl and Suphan volcanoes display transitional chemical characteristics ([Fig. 8](#); also see [Fig. 13](#)).

Keskin [2003] pointed out that these spatial and temporal variations in magma genesis, coupled with the uplift history of the region, can be explained by a model involving steepening of a northward subducting slab beneath a large subduction-accretion complex, namely the EAAC, followed by breakoff at around 10-11 Ma. He also argues that the slab, whose subduction was generating the Pontide arc in the north, was not attached to the Arabian plate. Instead, it was possibly attached to the Bitlis-Poturge block before breakoff (Fig. 31).

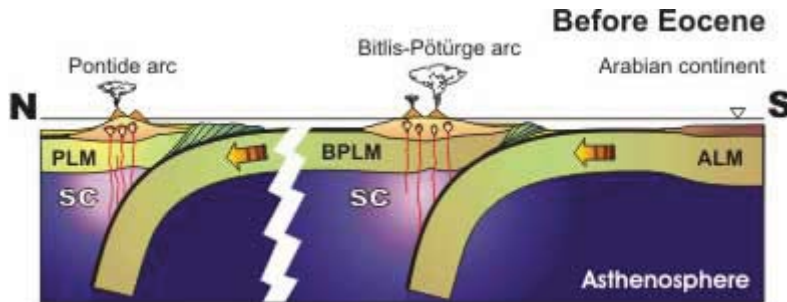

Figure 31. PLM,

BPLM and ALM: lithospheric mantle of the Pontides, Bitlis-Poturge Massif, and Arabian continent respectively. SC: subduction component. Figures 31 to 37 are from Keskin [2003].

The oceanic realm between the Bitlis-Poturge Massif and the Arabian plate had been closed much earlier (*i.e.* in the Late Eocene; Fig. 32 and 33). Therefore, it is not surprising that researchers failed to reach a consensus regarding timing of the collision event in the region. Tomographic images of the region provide no evidence for a lithospheric fragment currently sinking into the asthenosphere beneath the Eastern Anatolia region. What this may indicate is that the detachment of the oceanic lithosphere of the Arabian plate took place in the past, perhaps millions of years ago (*i.e.* 10-13 Ma; Figs. 33 and 34).

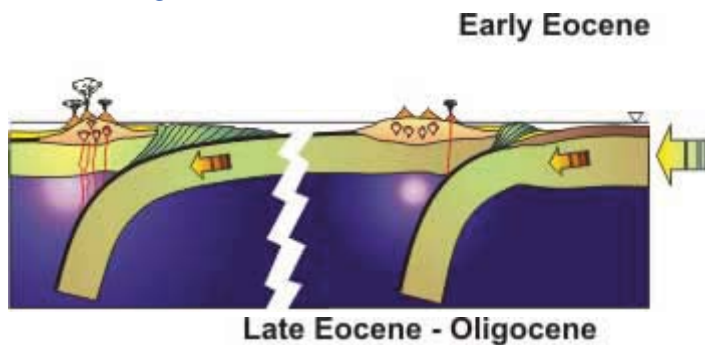

Figure 32

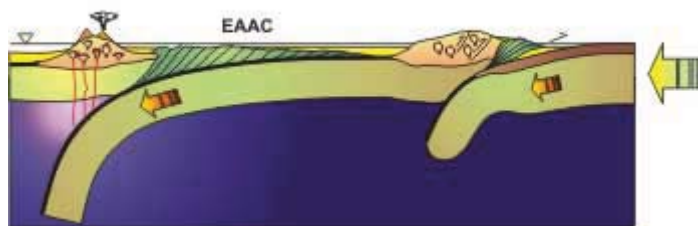

Figure 33. EAAC: the

Eastern Anatolian Accretionary Complex.



Figure 34

According to Sengor *et al.* [2003], the oceanic realm between the Pontides and the Bitlis-Poturge

Massif was completely closed in the Oligocene (Figs. 33 and 34). After a period between the Oligocene and Serravalian (*i.e.* 13-15 Ma), during which the EAAC was shortened and thus thickened over the slab, the hidden subduction possibly stopped (Fig. 34). As a result, being left unsupported by subduction, the oceanic lithospheric slab may have steepened and finally detached from the EAAC, opening out an asthenospheric mantle wedge, gradually widening to the south [Keskin, 2003]. This possibly created suction on the asthenosphere, generating mantle flow to the south (Figs. 35b and 36). Emplacement of the asthenospheric mantle with a subduction component and a potential temperature of 1280°C at shallow depths (~ 45-50 km) beneath the EAAC would have generated extensive adiabatic decompression melting. Also, it probably generated regional block uplift, producing the regional dome-like structure (Figs. 36 and 37).

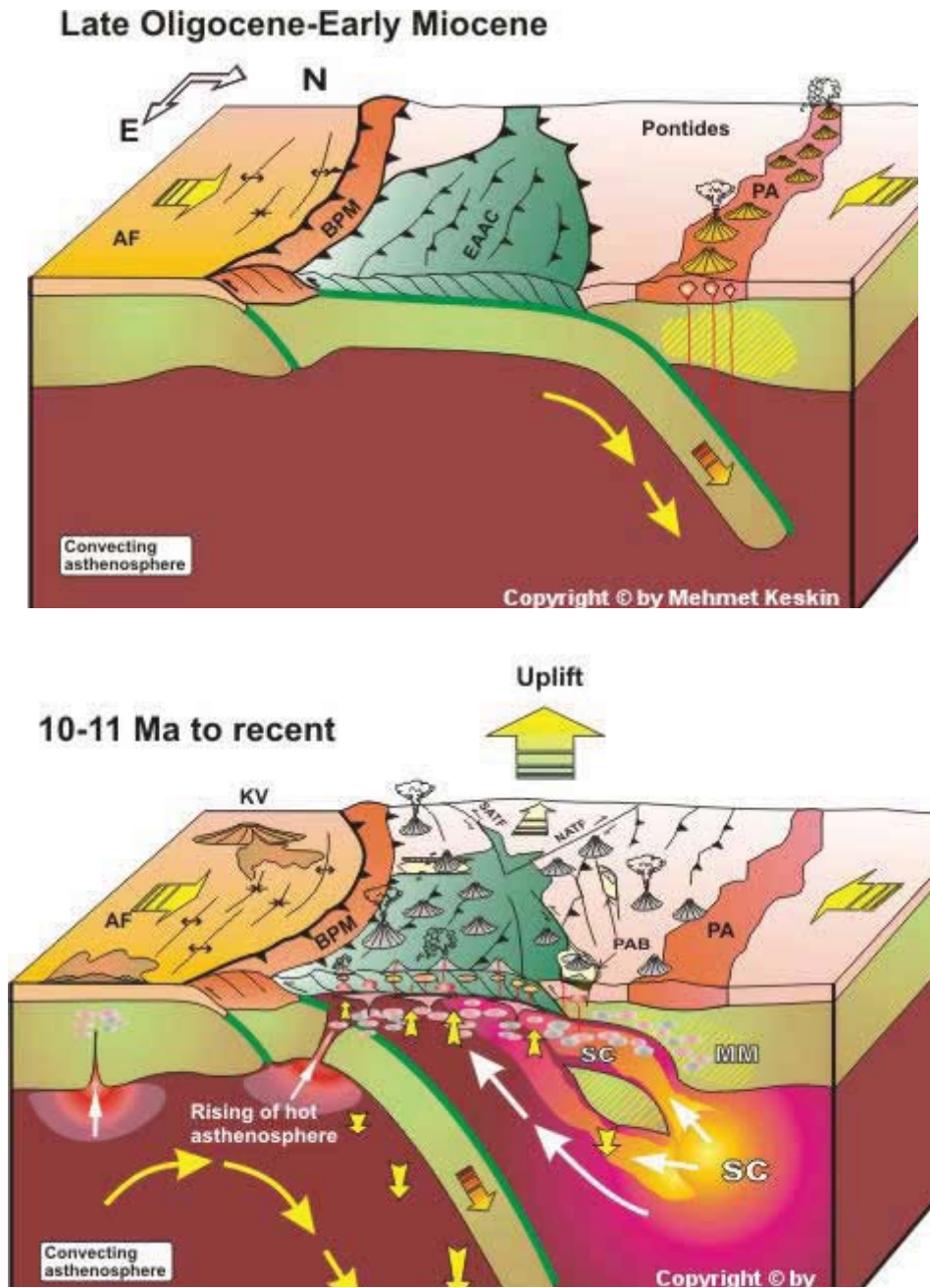

Figure 35. Block diagrams illustrating the slab-steepening & breakoff model for the Eastern Anatolian Collision Zone. Modified from Keskin [2003]. SC: subduction components. White arrows indicate the flow direction of the asthenosphere.

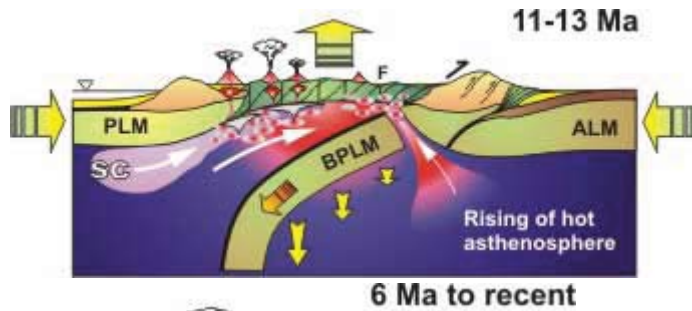

Figure 36

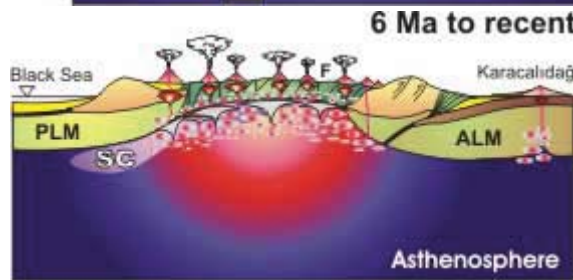

Figure 37

The presence of such asthenospheric flow may provide an answer to the question of why the volcanic activity initiated much earlier in the north on the EKP. Similarly, it explains better why the volcanic products are calc-alkaline with a distinct subduction signature in the north and this chemical signature changes gradually to alkaline (*i.e.* intraplate) to the south (Figs. 35a and b). The model proposed for Eastern Anatolia differs from the original model of *Davies & von Blanckenburg* [1995] since it involves a large accretionary complex and the steepening of the slab beneath it.

A number of recent studies address the importance of the slab breakoff process in the generation of magmatism in collision zones [*e.g.*, *Maheo et al.*, 2002; *Maury et al.*, 2000; *Williams et al.*, 2004]. The slab-steepening and breakoff process beneath large subduction-accretion complexes, accompanied by magma generation and the emplacement of magmas, may be a very important process in the making of continental crust in Turcic-type orogenic belts [*Sengor & Natal'in*, 1996] that comprise a large part of the Asian continent. It should be noted that the slab-steepening & breakoff model is viable only if the basement of a greater part of the region is represented by the EAAC as proposed by *Sengor et al.* [2003], and if there was only one north-dipping subducting slab beneath this accretionary prism. As the collision-related volcanic sequence masks the basement units over great distances, it is difficult to find evidence that sheds light on whether this interpretation is correct or not.

### Concluding remarks

The Eastern Anatolian high plateau can be regarded as a hot spot or “melting anomaly” coinciding with a regional domal structure which is squeezed in a collision zone in the N-S direction. By virtue of these features, the region closely resembles a mantle plume setting. However, the Eastern Anatolian domal uplift lies in a collision zone, in contrast to plume-related hot spots located in intraplate settings (*e.g.*, the Ethiopian high plateau).

The Eastern Anatolian lithosphere is, at present, bereft of its mantle component beneath a huge region [*Sengor et al.*, 2003]. This indicates that a huge piece (perhaps almost the whole thickness) of the mantle lithosphere was detached from the overlying crust in the past. If this removal of the denser mantle material is responsible for both the regional uplift and coeval volcanism, then the detachment must have occurred at about 13 Ma, at the same time as onset of those events. The volume opened up by the removal of the mantle lithosphere would have been filled by a hot, fertile asthenospheric upwelling, which would result in both the formation of the regional domal structure [*Sengor et al.*, 2003] and extensive magma generation and volcanism due to adiabatic decompression melting [*Keskin*, 2003].

I suggest that the mantle source region owed its exceptional fertility either to a subduction component inherited from a previous subduction event (*i.e.* the subduction beneath the Pontides during the Eocene and Oligocene), to the oceanic crustal material previously subducted beneath



the region, or to a combination of both. A process similar to the latter has recently been proposed by a number of researchers [e.g., Gasparik, 1997; Anderson, 2000; 2004a; Balyshv & Ivanov, 2001; Ivanov, 2003; Foulger et al., 2005] to explain low velocity anomalies in the mantle as well as the genesis of magmatism in exceptionally fertile mantle domains (e.g., the Icelandic hot spot; Foulger et al., 2005). As pointed out by Anderson [2004b], melting anomalies can result from fertile patches or regions of shallow mantle with low melting point, and this seems to be the case for Eastern Anatolia.

On the basis of combined geologic, geophysical and geochemical data, I thus argue that the Eastern Anatolian domal uplift [Sengor et al., 2003] is not related to a mantle plume. Instead its formation is linked to plate tectonic processes; namely either to slab-steepening and breakoff beneath a subduction-accretion complex [Keskin, 2003; Sengor et al., 2003] or to lithospheric delamination [Pearce et al., 1990; Keskin et al., 1998]. These processes can explain the voluminous magma generation and resultant volcanism in addition to the formation of the domal uplift across the region better than other competing geodynamic models.

The Eastern Anatolian example is particularly important as it shows that shallow plate tectonic processes can generate both regional lithospheric domal structures and great volumes of magma in the absence of a mantle plume. This observation contradicts the proposal of Sengor [2001] who argues that all hotspots and long-wavelength domes on the Earth's surface are related to mantle plumes.

Temporal and spatial variations in lava chemistry coupled with the uplift history and age relationships of the volcanic products in the Eastern Anatolian Collision Zone may be linked to slab-steepening and breakoff beneath a subduction-accretion complex in the south, where the mantle lid is absent (Fig. 35b, also see Fig. 12). Slab-steepening was possibly associated with asthenospheric flow that resulted in gradual change in the geochemical character of the volcanics erupted. I argue that lithospheric delamination might be a still more viable model for the northern areas (e.g. the Erzurum-Kars Plateau; Fig. 35b).

In addition to these two processes, strike-slip faulting might have played an important role in focusing magmas by generating localized extension and volcanism in associated pull-apart basins [Dewey et al., 1986; Pearce et al., 1990; Keskin et al., 1998]. In a recent study Cooper et al. [2002] support this view and suggest that the mafic magmas beneath NW Tibet might have been created by a mantle upwelling beneath the releasing bends of the strike-slip fault systems. They also present a model for magma generation in such systems. Therefore, like the Tibetan Plateau, the uplift and magmatism history of Eastern Anatolia may be related to more than one geodynamic process [e.g., Williams et al., 2004].

Further research is needed for a better understanding of collision-related magma genesis in Eastern Anatolia and its connection with slab breakoff and other alternative processes. Issues regarding source characteristics, melting mechanisms, the mode and extent of magma-crust interaction and crustal melting also needs further investigation.

#### References

- Al-Lazki, A., D. Seber, E. Sandvol, N. Turkelli, R. Mohamad, and M. Barazangi, Tomographic  $P_n$  velocity and anisotropy structure beneath the Anatolian plateau (eastern Turkey) and the surrounding regions, *Geophys. Res. Lett.*, **30**(24), 8043, doi:10.1029/2003GL017391, 2003.
- Allen, M., J. Jackson, and R. Walker, Late Cenozoic reorganization of the Arabia-Eurasia collision and the comparison of short-term and long-term deformation rates, *Tectonics*, **23**, TC2008, doi:10.1029/2003TC001530, 2004.
- Anderson, D.L., The thermal state of the upper mantle: no role for mantle plumes, *Geophys. Res. Lett.*, **27**, 3623-3626, 2000.
- Anderson, D.L., Reheating slabs by thermal conduction in the upper mantle, <http://www.mantleplumes.org/HotSlabs2.html>, 2004a.
- Anderson, D.L., What is a plume?, <http://www.mantleplumes.org/PlumeDLA.html>,

2004b.

- Barazangi, M., Continental collision zones: Seismotectonics and crustal structure, in *Encyclopedia of Solid Earth Geophysics*, edited by D. James, 58-75, Van Nostrand Reinhold Company, New York, 1989.
- Balyshev S.O. and A.V. Ivanov, Low-density anomalies in the mantle: ascending plumes and/or heated fossil lithospheric plates? *Doklady Earth Sciences*, **380**, no: 7, 858-862, 2001.
- Cooper, K.M., M.R. Reid, N.W. Dunbar, and W.C. McIntosh, Origin of mafic magmas beneath northwestern Tibet: Constraints from  $^{230}\text{Th}$ - $^{238}\text{U}$  Disequilibria, *Geochem. Geophys. Geosys.*, **3/1**, art. no. 1065, 2002.
- Davies, J.H., and F. von Blanckenburg, Slab breakoff: a model of lithosphere detachment and its test in the magmatism and deformation of collisional orogens, *Earth Planet. Sci. Lett.*, **129**, 85-102, 1995.
- De Paolo, D. J., Trace element and isotopic effects of combined wall-rock assimilation and fractional crystallisation, *Earth Planet. Sci. Lett.*, **53**, 189-202, 1981.
- Dewey J. F., M.R. Hempton, W.S.F. Kidd, F. Saroglu, and A.M.C. Sengor, Shortening of continental lithosphere: the neotectonics of Eastern Anatolia – a young collision zone, in *Collision Tectonics*, Geological Society special publications no: **19**, edited by M.P. Coward and A.C. Ries, 3-36, 1986.
- England, P.C. and G.A. Houseman, The mechanics of the Tibetan Plateau, *Philos. Trans. Royal. Soc. London*, **A326**, 301-320, 1988.
- Ercan, T., T. Fujitani, J-I. Madsuda, K. Notsu, S. Tokel, and U.I. Tadahide, Dogu ve guneydogu Anadolu Neojen-Kuvaterner volkanitlerine iliskin yeni jeokimyasal, radyometrik ve izotopik verilerin yorumu, *M.T.A. Dergisi*, **110**, 143-164, 1990.
- Esenli, F. and S.C. Genc, Preliminary report on the petrography, petrology and geochemistry of mantle peridotite xenoliths in alkali basalts from the Eastern Thrace region, NW Turkey, *Geologica Capratica*, submitted.
- Foulger, G.R., [Plumes or plate tectonic processes?](#) *Astron. Geophys.*, **43**, 6.19-6.23, 2002.
- Foulger, G.R., J.H. Natland and D.L. Anderson, [A source for Icelandic magmas in remelted Iapetus crust](#), *J. Volc. Geotherm. Res.*, **141**, 23-44, 2005.
- Frey, F.A., The origin of pyroxenites and garnet pyroxenites from Salt Lake Crater, Oahu, Hawaii: trace element evidence, *Am. J. Sci.*, **280-A**, 427-449, 1980.
- Fujimaki, H., M. Tatsumoto, and K. Aoki, Partition coefficients of Hf, Zr and REE between phenocrysts and groundmasses. Proceedings of the Fourteenth Lunar and Planetary Science Conference, Part 2, *J. Geophys. Res. Suppl.*, **89**, B662-672, 1984.
- Gasparik, T., A model for the layered upper mantle, *Phys. Earth Planet. Int.*, **100**, 197-212, 1997.
- Gelati, R., Miocene marine sequence from Lake Van, Eastern Turkey, *Riv. Ital. Paleont. Stratigr.*, **81**, 477-490, 1975.
- Gezdirici, Y. Near Real-Time Earthquake Monitor for Turkey, freeware software, <http://www.gezdirici.net/members/yakup/projects/eqmon/>, 2001.
- Gök, R., E. Sandvol, N. Türkelli, D. Seber, and M. Barazangi,  $S_n$  attenuation in the Anatolian and Iranian plateau and surrounding regions, *Geophys. Res. Lett.*, **30(24)**, 8042,

doi:10.1029/2003GL018020, 2003.

- Gök, R., N. Turkelli, E. Sandvol, D. Seber, and M. Barazangi, Regional wave propagation in Turkey and surrounding regions, *Geophys. Res. Lett.*, **27**(3), 429-432, 2000.
- Hearn, T.N., and J.F. Ni, *Pn* velocities beneath continental collision zones: The Turkish-Iranian Plateau, *Geophys. J. Int.*, **117**, 273-283, 1994.
- Housman, G.A., D.P. McKenzie, and P. Molnar, Convective instability of a thickened boundary layer and its relevance for the thermal evolution of continental collision belts, *J. Geophys. Res.*, **86**, 6115-6132, 1981.
- Innocenti, F., P. Manetti, R. Mazzuoli, G. Pasquaré, and L. Villari, Anatolia and north-western Iran, in *Andesites*, Ed. R.S. Thorpe, John Wiley & Sons, 1982a.
- Innocenti, F., R. Mazzuoli, G. Pasquaré, F. Radicati di Brozolo, and L. Villari, Tertiary and Quaternary volcanism of the Erzurum-Kars area (Eastern Turkey): geochronological data and geodynamic evolution, *J. Volc. Geotherm. Res.*, **13**, 223-240, 1982b.
- Irvine, T.N. and W.R.A. Baragar, A guide to the chemical classification of the common volcanic rocks, *Canadian J. Earth Sci.*, **8**, 523-548, 1971.
- Irving, A.J. and F.A. Frey, Distribution of trace elements between garnet megacrysts and host volcanic liquidus of kimberlitic to rhyolitic composition, *Geochim. Cosmochim. Acta*, **42**, 771-787, 1978.
- Ivanov, A.V., Plumes or reheated slabs?, <http://www.mantleplumes.org/HotSlabs1.html>, 2003.
- Karapetian, S.G., R.T. Jrbashian, and A.K. Mnatsakanian, Late collision rhyolitic volcanism in the north-eastern part of the Armenian Highland, *J. Volc. Geotherm. Res.*, **112** (1-4), 189-220, 2001.
- Kaufman, P.S. and L.H. Royden, Lower crustal flow in an extensional setting: Constraints from the Halloran Hills region, eastern Mojave Desert, California. *J. Geophys. Res.*, **99**, 15723-15739, 1994.
- Keskin, M. Genesis of collision-related volcanism on the Erzurum-Kars Plateau, Northeastern Turkey, *Unpublished PhD thesis*, Univ. Durham, U.K., 1994.
- Keskin, M., FC-Modeler: a Microsoft® Excel® spreadsheet program for modeling Rayleigh fractionation vectors in closed magmatic systems, *Computers & Geosciences*, **28**/8, 919-928, 2002.
- Keskin, M., J.A. Pearce, and J.G. Mitchell, Volcano-stratigraphy and geochemistry of collision-related volcanism on the Erzurum-Kars Plateau, North Eastern Turkey, *J. Volc. Geotherm. Res.*, **85**(1-4), 355-404, 1998.
- Keskin, M., J.A. Pearce, P.D. Kempton and P. Greenwood, Magma-crust interactions and magma plumbing in a collision setting: Sr-Nd-Pb-O isotope and trace element geochemistry of the lavas from the Erzurum-Kars Plateau, Northeastern Anatolia, Turkey, under revision.
- Keskin, M., Magma generation by slab steepening and breakoff beneath a subduction-accretion complex: An alternative model for collision-related volcanism in Eastern Anatolia, Turkey, *Geophys. Res. Lett.*, **30**(24), 8046, doi:10.1029/2003GL018019, 2003.
- Koronovskiy, N.V. and L.I. Demina, A model for the collision volcanism of the Caucasian segment of the Alpine Fold Belt, *Dokl. Akad. Nauk Rossi.*, **350**, 519-522 (in Russian), 1996.

- Kuno, H., Lateral variation of basalt magma types across continental margins and island arcs, *Bull. Volcanol.*, **29**, 195-222, 1966.
- Maggi A. and K. Priestley, Surface waveform tomography of the Turkish-Iranian plateau, *Geophys. J. Int.*, **160** (3): 1068-1080, 2005.
- Maggi, A., K. Priestley, and D. McKenzie, Seismic structure of the Middle East, *Eos Trans. AGU*, 83(47), Fall Meet. Suppl., Abstract S51B-1041, 2002.
- Maheo, G., S. Guillot, J. Blichert-Toft, Y. Rolland, and A. Pecher, A slab breakoff model for the Neogene thermal evolution of South Karakorum and South Tibet, *Earth Planet. Sci. Lett.*, **195**(1-2), 45-58, 2002.
- Maury, R.C., S. Fourcade, C. Coulon, M. El Azzouzi, H. Bellon, A. Coutelle, A. Oubadi, B. Semroud, M. Megartsi, J. Cotton, Q. Belanteur, A. Louni-Hacini, A. Pique, R. Capdevila, J. Hernandez, and J. P. Rehault, Post-collisional Neogene magmatism of the Mediterranean Maghreb margin: a consequence of slab breakoff, *Comptes Rendus de la Academie Des Sciences Serie II Fascicule A Sciences de la Terre et des Planets*, **331**(3), 159-173, 2000.
- McKenzie, D. P., and M. J. Bickle, The volume and composition of melt generated by extension of the lithosphere, *J. Pet.*, **29**, 625-679, 1988.
- McKenzie, D.P. and R.K. O'Nions, Partial melt distribution from inversion of rare earth element concentrations, *J. Pet.*, **32**, 1021-1091, 1991.
- McKenzie, D.P., Active tectonics of the Mediterranean, *Geophys. J. R. Astr. Soc.*, **30**(2), 109-185, 1972.
- Mitchell, J. and R. Westaway, Chronology of Neogene and Quaternary uplift and magmatism in the Caucasus: constraints from K - Ar dating of volcanism in Armenia, *Tectonophysics*, **304**, 157-186, 1999.
- National Iranian Oil Company, Geological cross-sections north-west Iran, *Natl. Iranian Oil Co.*, Tehran, 1977.
- Pearce, J.A., J.F. Bender, S.E. De Long, W.S.F. Kidd, P.J. Low, Y. Guner, F. Saroglu, Y. Yilmaz, S. Moorbath, and J.G. Mitchell, Genesis of collision volcanism in Eastern Anatolia, Turkey, *J. Volcanol. Geotherm. Res.*, **44**, 189-229, 1990.
- Platt, J.P. and P.C. England, Convective removal of lithosphere beneath mountain belts: Thermal and mechanical consequences. *Am. J. Sci.*, **293**, 307-336, 1993.
- Reilinger, R., S. McClusky, B. Oral., R. King, N. Toksoz, A. Barka, I. Kinik, O. Lenk, and I. Sanli, Global positioning system measurements of present-day crustal movements in the Arabia-Africa-Eurasia plate collision zone, *J. Geophys. Res.*, **102**, 9983-9999, 1997.
- Rollinson, H.R., Using geochemical data: evaluation, presentation, interpretation, Longman Scientific & Technical, *John Wiley Sons*, New York, 344 pp, 1993.
- Rotstein, Y., and A.L. Kafka, Seismotectonics of the southern boundary of Anatolia, eastern Mediterranean region, subduction, collision and arc jumping, *J. Geophys. Res.*, **87**, 7694-7706, 1982.
- Sandvol, E., D. Seber, M. Barazangi, N. Turkelli, C. Gurbuz, S. Kuleli, H. Karabulut, E. Zor, R. Gok, T. Bekler, E. Arpat, and S. Bayraktutan, Eastern Turkey Seismic Experiment, *IRIS Newsletter*, **2000**(1), 2000.
- Sandvol, E., N. Turkelli, and M. Barazangi, The Eastern Turkey Seismic Experiment: The study of a young continent-continent collision, *Geophys. Res. Lett.*, **30**(24), 8038, doi:10.1029/2003GL018912, 2003a.

- Sandvol, E., N. Turkelli, E. Zor, R. Gok, T. Bekler, C. Gurbuz, D. Seber, and M. Barazangi, Shear wave splitting in a young continent-continent collision: An example from Eastern Turkey, *Geophys. Res. Lett.*, **30**(24), 8041, doi:10.1029/2003GL017390, 2003b.
- Sen, P.A., A. Temel and A. Gourgaud, Petrogenetic modelling of Quaternary post-collisional volcanism: a case study of central and eastern Anatolia, *Geol. Mag.*, **141**(1), 81–98, DOI: 10.1017/S0016756803008550, 2004.
- Sengor, A.M.C., The Turkish-Iranian High Plateau as a tectonic structure, *Workshop on the Tectonics of Eastern Turkey and the Northern Anatolian plate*, Erzurum, Turkey, p. 28, 2002.
- Sengor, A.M.C., and B. Natal'in, Turcic-type orogeny and its role in the making of the continental crust, *Annu. Rev. Earth Planet. Sci.*, **24**, 263-337, 1996.
- Sengor, A.M.C., and W.S.F. Kidd, Post-collisional tectonics of the Turkish-Iranian Plateau and a comparison with Tibet, *Tectonophysics*, **55**, 361-376, 1979.
- Sengor, A.M.C., and Y. Yilmaz, Tethyan evolution of Turkey: a plate tectonic approach, *Tectonophysics*, **75**, 181-241, 1981.
- Sengor, A.M.C., Elevation as indicator of mantle-plume activity, *Geol. Soc. Am., Sp. Pap.*, **352**, 183-225, 2001.
- Sengor, A.M.C., S. Ozeren, E. Zor, and T. Genc, East Anatolian high plateau as a mantle-supported, N-S shortened domal structure, *Geophys. Res. Lett.*, **30**(24), 8045, doi:10.1029/2003GL017858, 2003.
- Shaw, D.M., Trace element fractionation during anatexis, *Geochim. Cosmochim. Acta*, **34**, 237-243, 1970.
- Sun, S.S. and W.F. McDonough, Chemical and isotopic systematics of oceanic basalts: implications for mantle composition and processes: In *Magmatism in Ocean Basins* (A.D. Saunders & M.J. Norry eds.), *Geol. Soc. Lond. Spec. Pub.*, **42**, 313-345, 1989.
- Taylor, S.R. and S.M. McLennan, *The continental crust: its composition and evolution*, Geoscience Texts, Blackwell Scientific Publications, London, 312 pp., 1985.
- Topuz, G., R. Altherr, A. Kalt, M. Satör, O. Werner, and W.H. Schwarz, Aluminous granulites from the Pulur complex, NE Turkey: a case of partial melting, efficient melt extraction and crystallization, *Lithos*, **72**, 183-207, 2004.
- Tokel, S., Mechanism of crustal deformation and petrogenesis of the Neogene volcanics in East Anatolia, special publication of *Turkiye Jeoloji Kurumu, Ketin Symposium*, Eds. T. Ercan and M.A. Caglayan, 121-130, 1985.
- Turkelli, N., E. Sandvol, E. Zor, R. Gok, T. Bekler, A. Al-Lazki, H. Karabulut, S. Kuleli, T. Eken, C. Gurbuz, S. Bayraktutan, D. Seber and M. Barazangi, Seismogenic zones in Eastern Turkey, *Geophys. Res. Lett.*, **30**(24), 8039, doi:10.1029/2003GL018023, 2003.
- Turcotte, D.L. Mechanism of crustal deformation, *J. Geol. Soc. Lond.*, **140**, 701-724, 1983.
- Williams, H.M., S.P. Turner, J.A. Pearce, S.P. Kelley, and N.B.W. Harris, Nature of the source regions for post-collisional, potassic magmatism in Southern and Northern Tibet from geochemical variations and inverse trace element modeling, *J. Pet.*, **45**(3), 555-607, 2004.
- Wilson, M., *Igneous petrogenesis: a global tectonic approach*, Unwin Hyman, London, 466 pp., 1989.
- Yilmaz Y, Y. Guner and F. Saroglu, Geology of the quaternary volcanic centers of the east

Anatolia, *J. Volc. Geotherm. Res.*, **85**(1-4), 173-210, 1998.

- Yilmaz, Y., O. Tuysuz, E. Yigitbas, S.C. Genc, and A.M.C. Sengor, Geology and tectonic evolution of the Pontides, in *Regional and Petroleum geology of the Black Sea and Surrounding Region*, Ed. A.G. Robinson, *AAPG Memoir* **68**, 183-226, 1997.
- Zor, E., Gurbuz, C., Turkelli, N., Sandvol, E., Seber, D. and Barazangi, M., The crustal structure of the East Anatolian Plateau from receiver functions, *Geophys. Res. Lett.*, **30**(24), 8044, doi:10.1029/2003GL018192, 2003.

*last updated 20th June, 2005*